

SKIPPER

2 Axis Doppler Speed Log

DL850 (540 kHz)

Operation and Installation Manual

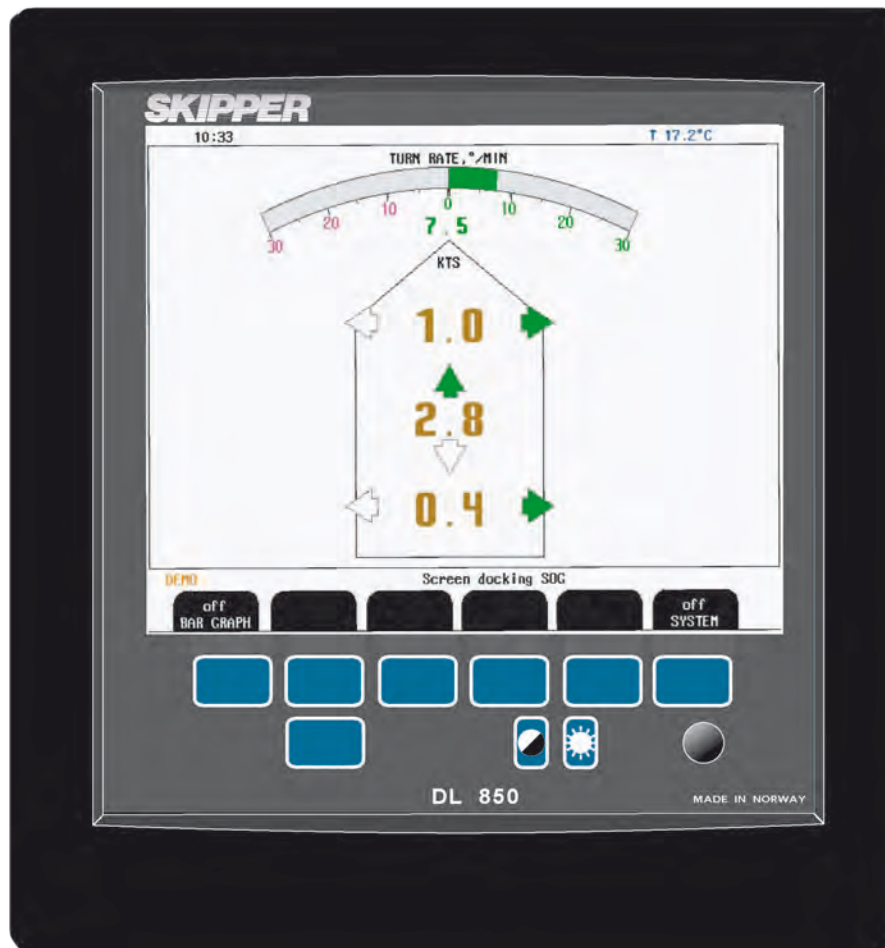

SKIPPER Electronics AS
Enebakkveien 150
P. O. Box 151, Manglerud
0612 Oslo, Norway
www.skipper.no

Telephone: +47 23 30 22 70
Telefax: +47 23 30 22 71
E-mail: support@skipper.no
Co. reg. no: NO-965378847-MVA

Document no: **DM-D001-SC** Rev 4.01.11A
Edition: 20100415

Weitergabe sowie vervielfältigung dieser unterlage, verwertung und mitteilung ihres inhaltes nicht gestattet, soweit nicht ausdrücklich zugestanden. Zuwiderhandlungen verpflichten zu schadenersatz.

Toute communication ou reproduction de ce document, toute exploitation ou communication de ou son contenu sont interdites, sauf autorisation expresse. Tout manquement à cette règle est illicite et expose son auteur au versement de dommages et intérêts.

Copying of this document, and giving it to others and the use or communication of contents thereof, are forbidden without express authority. Offenders are liable to the payment of damages.

Sin nuestra expresa autorización, queda terminantemente prohibida la reproducción total o parcial de este documento, así como su uso indebido y/o su exhibición o comunicación a terceros. De los infractores Se exigirá el correspondiente resarcimiento de daños y perjuicios.

Contents

1. INTRODUCTION.....	6
System Summary	6
Sensor (Transducer) and Transceiver	6
Operator Unit	7
Interfacing	7
Outputs.....	7
Inputs.....	7
Alarms	7
2. OPERATION.....	10
Primary Screens	11
Setup and Function Control Screens.....	18
Principal Functions	31
Doppler Log Principle.....	31
Bottom Track Characteristics	31
Water Track Characteristics	31
Docking Function - Option	31
Echo sounder option.....	31
Non-volatile Parameter Memory	32
Fixed Key Functions	32
Screen Select	32
Backlight adjustment (brightness).....	32
Day/Night	32
Soft Key Functions.....	33
3. USER MAINTENANCE	34
Transducer Maintenance.....	34
Operator Unit and Transceiver Unit Maintenance.....	34
4. INSTALLATION	35
Standard System Supply	35
Handling warning	35
Transducer Installation	36
Location.....	36
Operator Unit Installation	36
AC Voltage selection.....	37
Fuses	37
Back-up Battery Jumper JP200.....	38
Power indication and function LEDs	39
Interfacing	40
Alarm relay	40
Log Pulse Outputs	40

Inputs.....41
Analogue interfaces41
NMEA interface.....41
Options41
Repeater/Slaves41
External Interface Ports42
Operator Unit - Connecting External Equipment43
Operator unit - Terminal connections.....44
Misc I/O connections45
Alarm connections46
5. START-UP AND SYSTEM ADAPTION.....47
System Adaption.....47
Analogue outputs and log pulse outputs range selection47
Units of Measure.....47
NMEA Setup47
Doppler log transmitted (talker) (IEC 61162-1:2007(E) (NMEA 0183) messages.....48
Docking option parameter setup.....48
6. CALIBRATION PROCEDURE49
Activation of the hidden menus50
7. TROUBLE SHOOTING54
Basic System Integrity54
Installation problems55
Interface problems56
Basic functionality.....56
Typical Status Screen Contents57
Typical Oscilloscope Screen Contents.....59
Master Reset Procedure.61
8. SPECIFICATIONS.....62
Dimensions.....62
Functional Properties62
Performance63
Environmental.....63
9. SERVICE.....64
10. APPENDIX 165
Miscellaneous Installation Diagrams65
PCB positions in Transceiver Unit.....66
LEDs on PCBs in Transceiver Unit67
DL 850 System Overview.....68

Operator Unit - Transceiver Unit Interconnection	69
540 kHz Sensor Cable Connection.....	70
Transceiver Unit Dimensions	71
Dimensional Drawing Cabinet	72
11. APPENDIX 2	73
Screen scope settings	73
12. APPENDIX 3	79
Upgrading Software	79

1. Introduction

System Summary

The DL850 is a navigation, 2 axis (transversal and longitudinal) Doppler speed log with a large LCD. The display graphics is continuously shown on the LCD along with available navigation details. Comprehensive interfaces are available including IEC 61162-1:2007(E) (NMEA 0183) input and output. All IMO (International Maritime Organization) requirements for speed logs are met or exceeded.

Sensor (Transducer) and Transceiver

The Doppler sensor consists of a head with hydro-acoustic elements. Two different versions of the sensor head (270 kHz and 540 kHz) exist, both with 2 axis log function. The 540 kHz, has in addition, one extra element for the auxiliary echo sounder option. The sensor is connected to a transceiver cabinet located within 40 m of the sensor.

The connection from the transceiver cabinet to the operator unit is via a serial RS-422 data link and may be up to 300 m. Transceiver and operator unit power supply options are 115/230 V AC or 24 V DC. The power consumption for the transceiver unit is app. 80 Watt at 115/230 V AC or 60 Watt at 24 V DC.

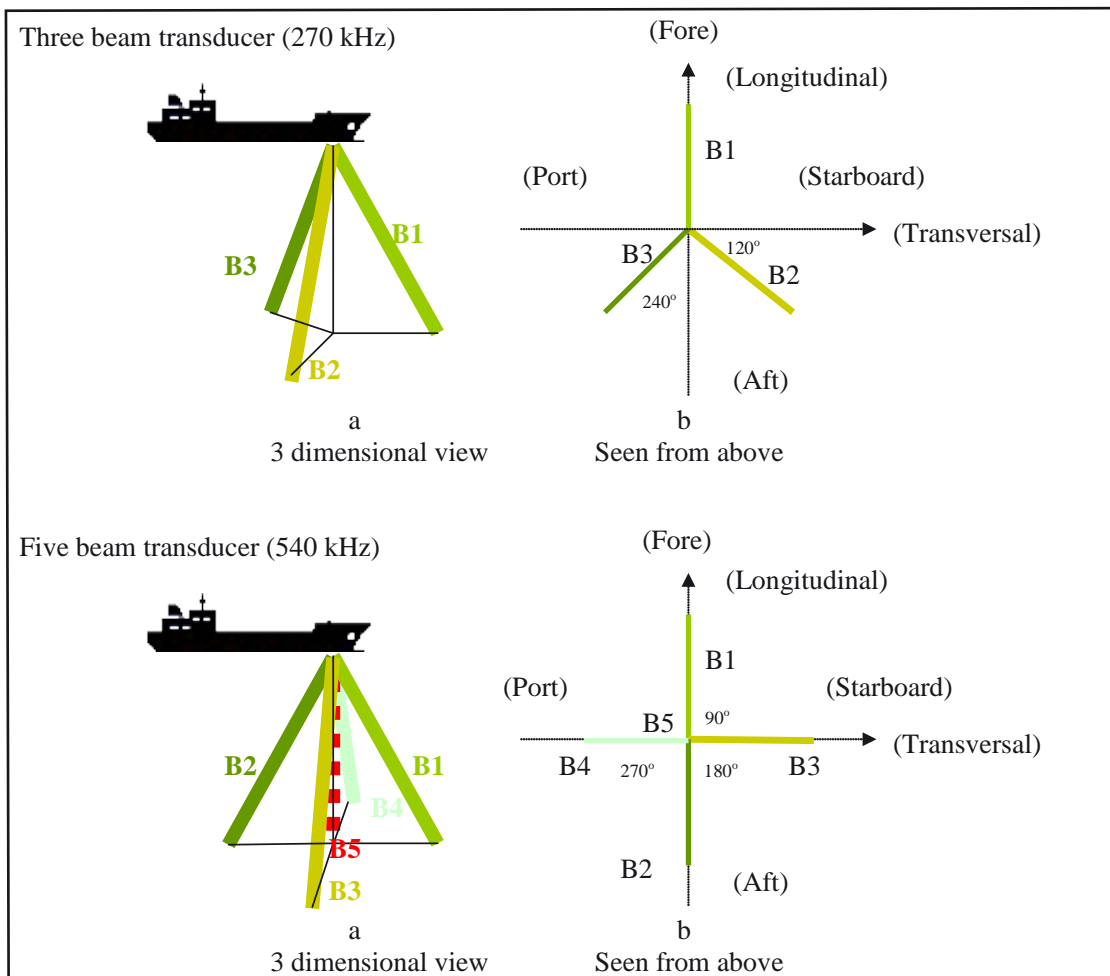

Operator Unit

The operator unit contains a graphic LCD display and a keyboard with fixed keys, soft keys and a rotating encoder. The function of each soft key button depends on the active screen, and the buttons are labelled on the lower rim of the LCD. The display is back lit, and back light intensity may be adjusted by the user. Various user-selectable information layouts adapted to typical operational situations, may be displayed continuously on the LCD. The operator unit can be flush mounted, wall mounted or bracket mounted. Operator unit power supply options are 115/230 V AC or 24 V DC. The power consumption is app. 70 Watt at 115/230 V AC or 50 Watt at 24 V DC.

Interfacing

The operator unit has various interface possibilities.

Outputs

- 3 log outputs 10/100/200/400/1000 pulses per nautical mile.
- 2 outputs also gives speed direction.
- 3 analogue outputs 0 - 10 V or 4 - 20 mA.
- IEC 61162-1:2007(E) (NMEA 0183) interface output of speed/distance, temperature, alarm and depth information.
- Functional alarm relay.
- Power failure alarm.
- External VGA monitor.

Inputs

- IEC 61162-1:2007(E) (NMEA 0183) interface input for alarm, position, rate of turn, heading and UTC (Coordinated Universal Time).
- External alarm reset.

Alarms

High and low speed alarms may be selected from the menus (screen pilot, menu 1). Alarms are provided on both a potential free relay contact and as NMEA messages. Both ways can be used for interface to external alarm systems. An optocoupler output is used as a separate output for power failure alarm.

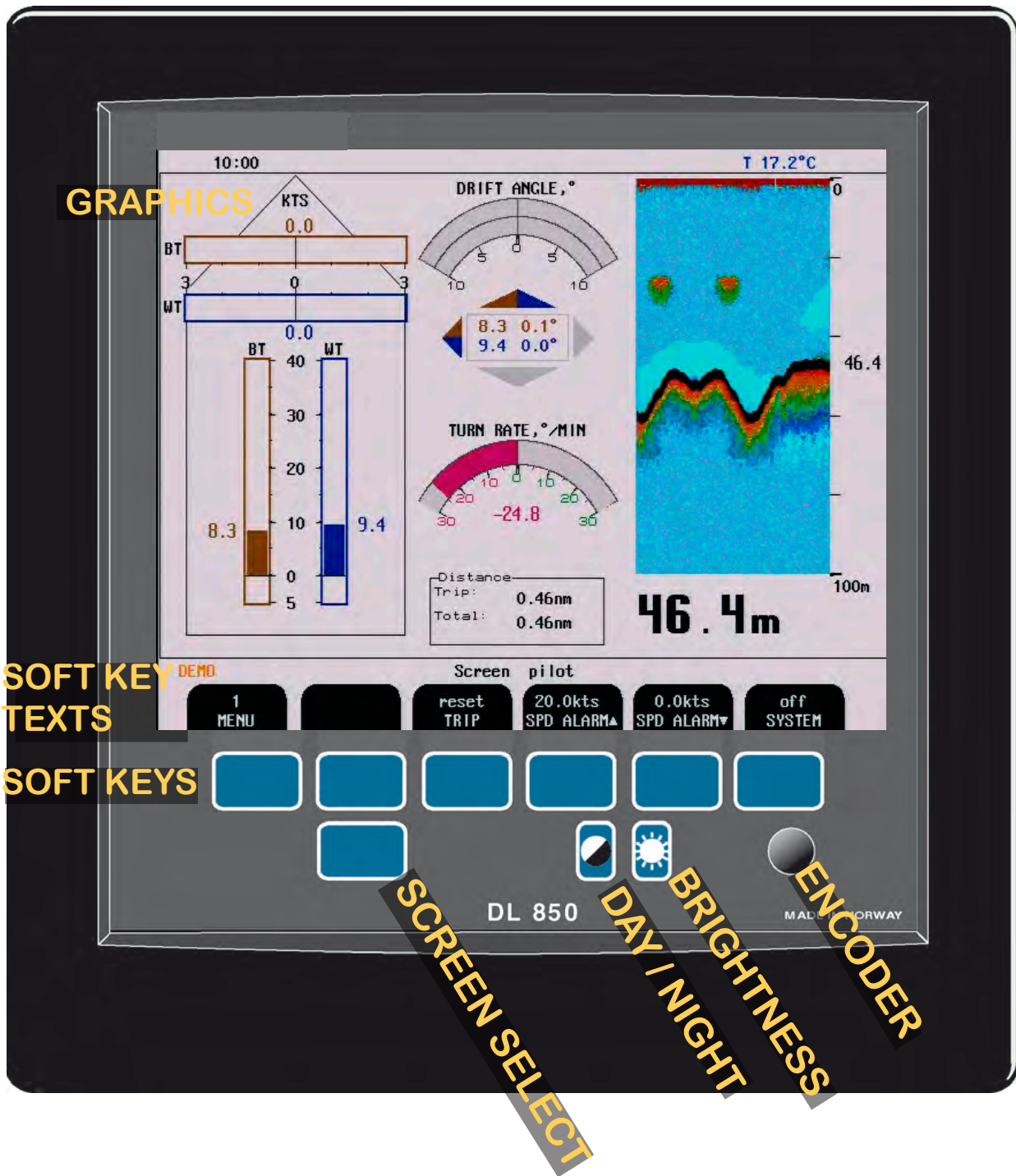

Fig. 1.1 Operator unit, panel layout.

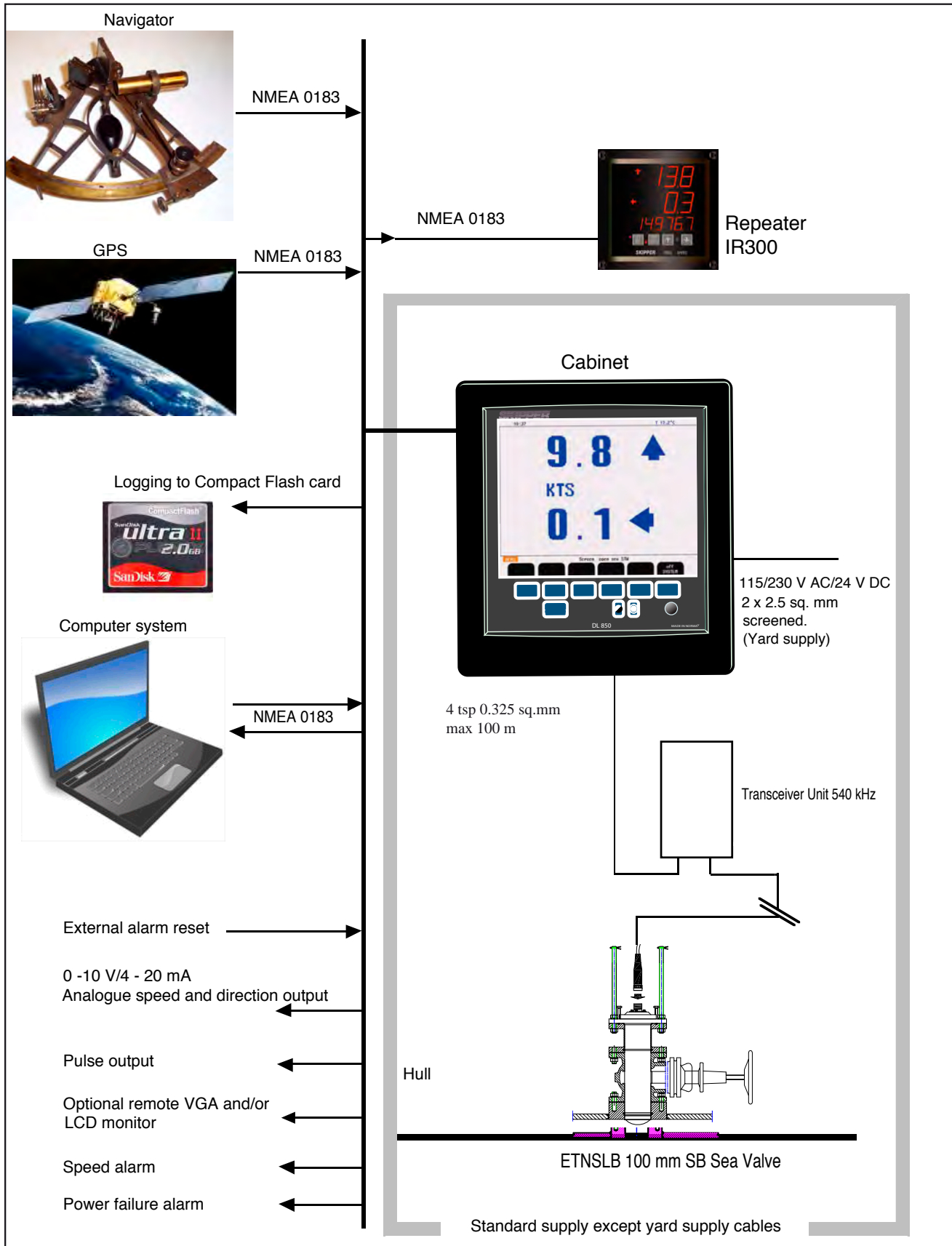

Fig. 1.2 System Diagram

2. Operation

When the installation is complete, and power is connected to the operator unit, the system is switched on/off by a power switch inside the cabinet. The unit can also be switched off by pressing the system OFF soft key button.

Note: The unit is still energized. Do not perform any connections before switching off the mains on the terminal PCB inside the cabinet.

Parameter entry

The fixed function buttons and the soft key buttons along with the rotating encoder, facilitates entry of parameters and other data. The following flowchart illustrates the procedure for changing settings. The various screens are shown in detail in the operation section.

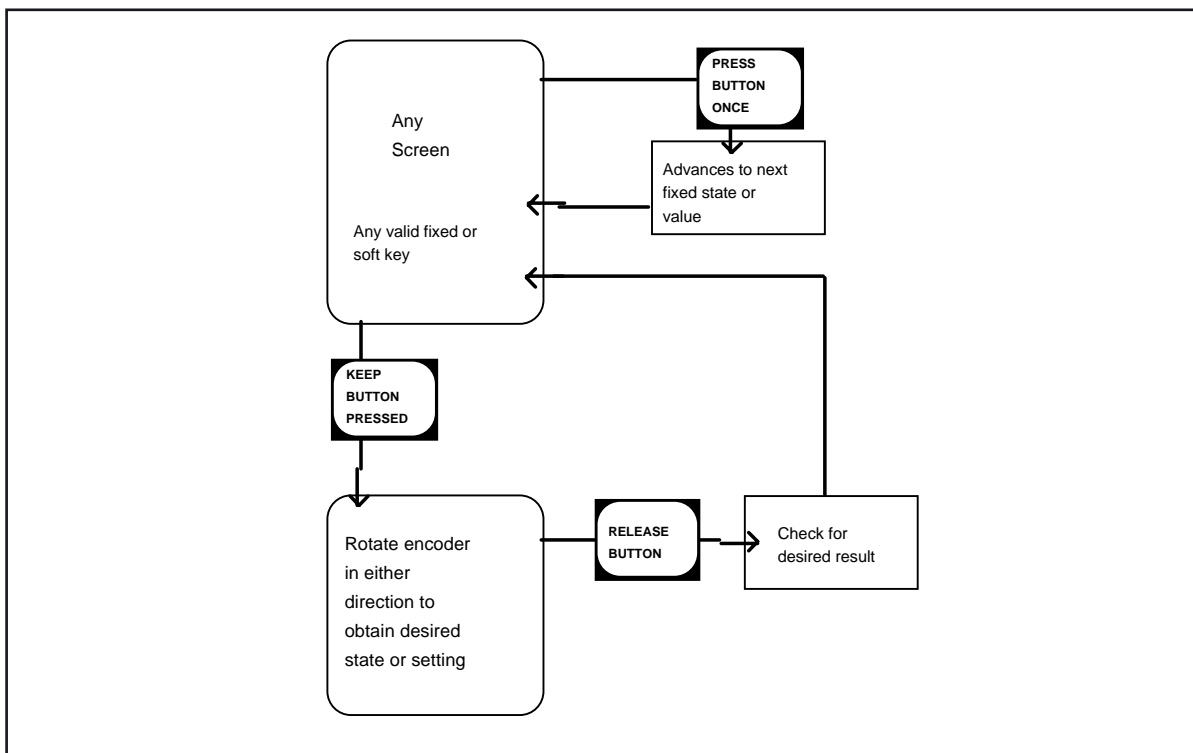

Fig. 2.1 Setting and Parameter Entry Flowchart

Example of parameter entry

Suppose you want to enter a value of 15 knots for the high speed alarm. Press the SPD ALARM▲ soft key in screen pilot, menu 1, and keep it pressed while you turn the encoder until you reach 15 knots. Release the encoder and release the SPD ALARM▲ soft key.

Primary Screens

Each of the operation screens contains a graphic picture and one or more menu sets configured on the 6 soft key buttons. The three first screens are covering the primary functions. Manoeuvring within these screens are easily done by pressing the screen select button.

The various screens can also be selected by keeping the screen select button pressed and rotating the encoder in either direction. Turning the encoder clockwise cycle the screens as shown in figure below, and counter clockwise rotation cycles the screens in the opposite direction.

The screen layouts are outlined in the following pages. The various menus and soft key functions are described with each screen

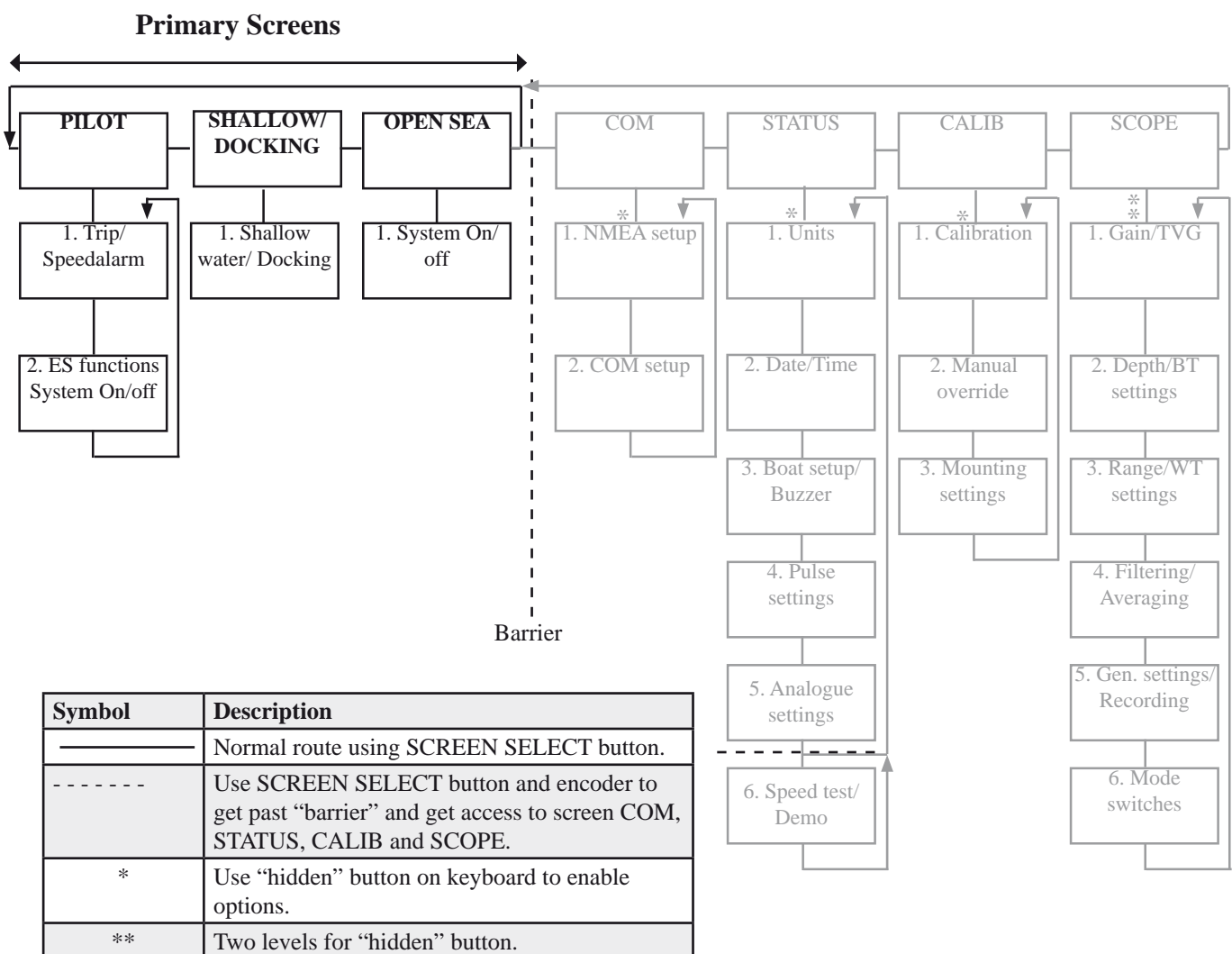

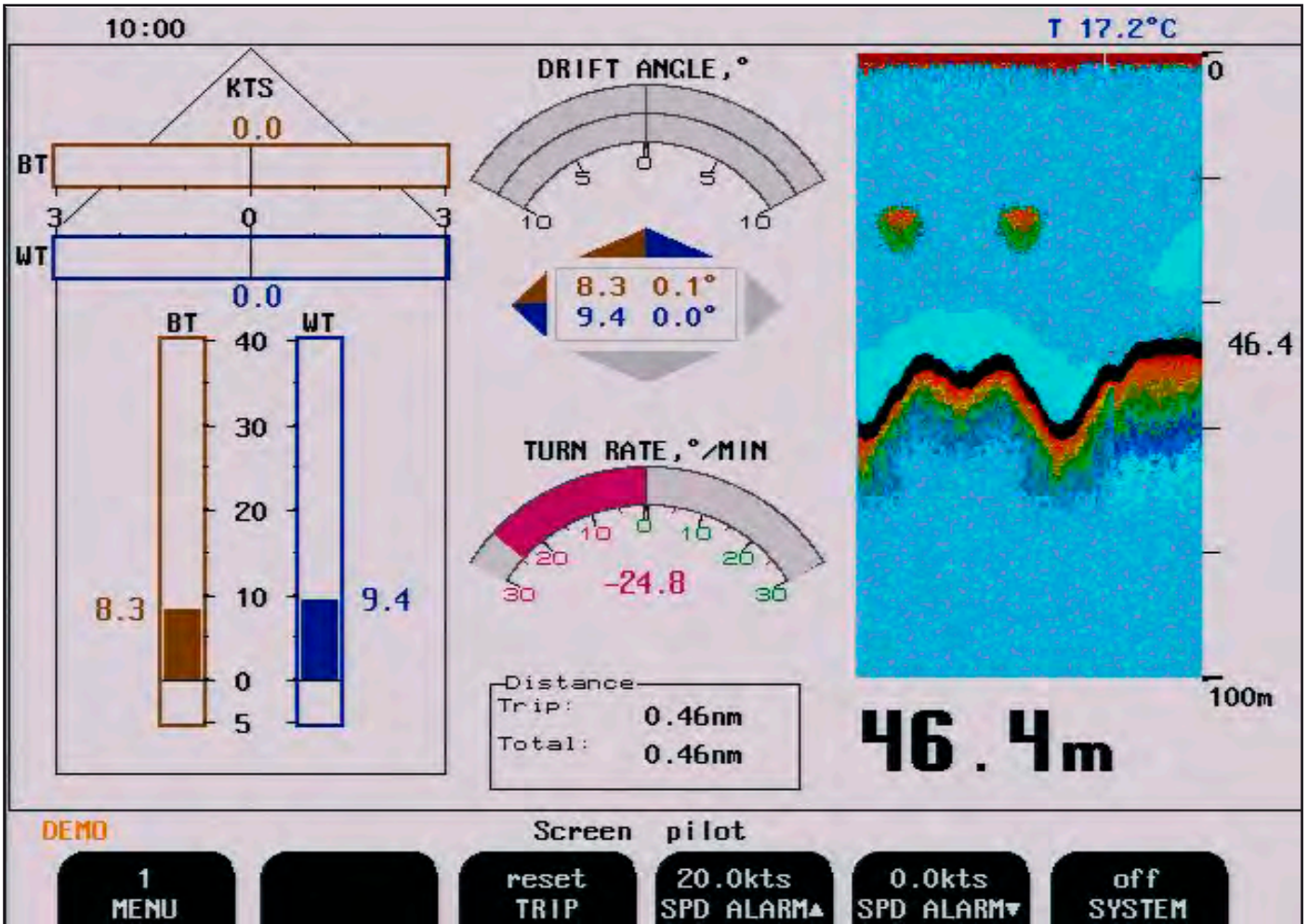

The various soft key menus are selected by pressing repeatedly the MENU button on the left side of the soft key menu. The number on the button indicates present active menu.

- “Brown” is speed over ground.
- “Blue” is speed through water.
- Drift angle is the angle between the longitudinal axis and resultant speed vector.

Screen pilot, Menu 1, trip/speed alarm.

Soft key	Name	Range/value	Default value	Description	Activate with hidden button
1	MENU	1 - 2	1	Menu 1 is selected.	
2				Not used.	
3	TRIP	Reset		Trip distance counter reset.	
4	SPD ALARM ▲	-48.4 - 48.6 kts	20.0 kts	High speed alarm.	
5	SPD ALARM	-48.6 - 48.4 kts	0.0 kts	Low speed alarm.	
6	SYSTEM	On/Off	On	Turn system off.	

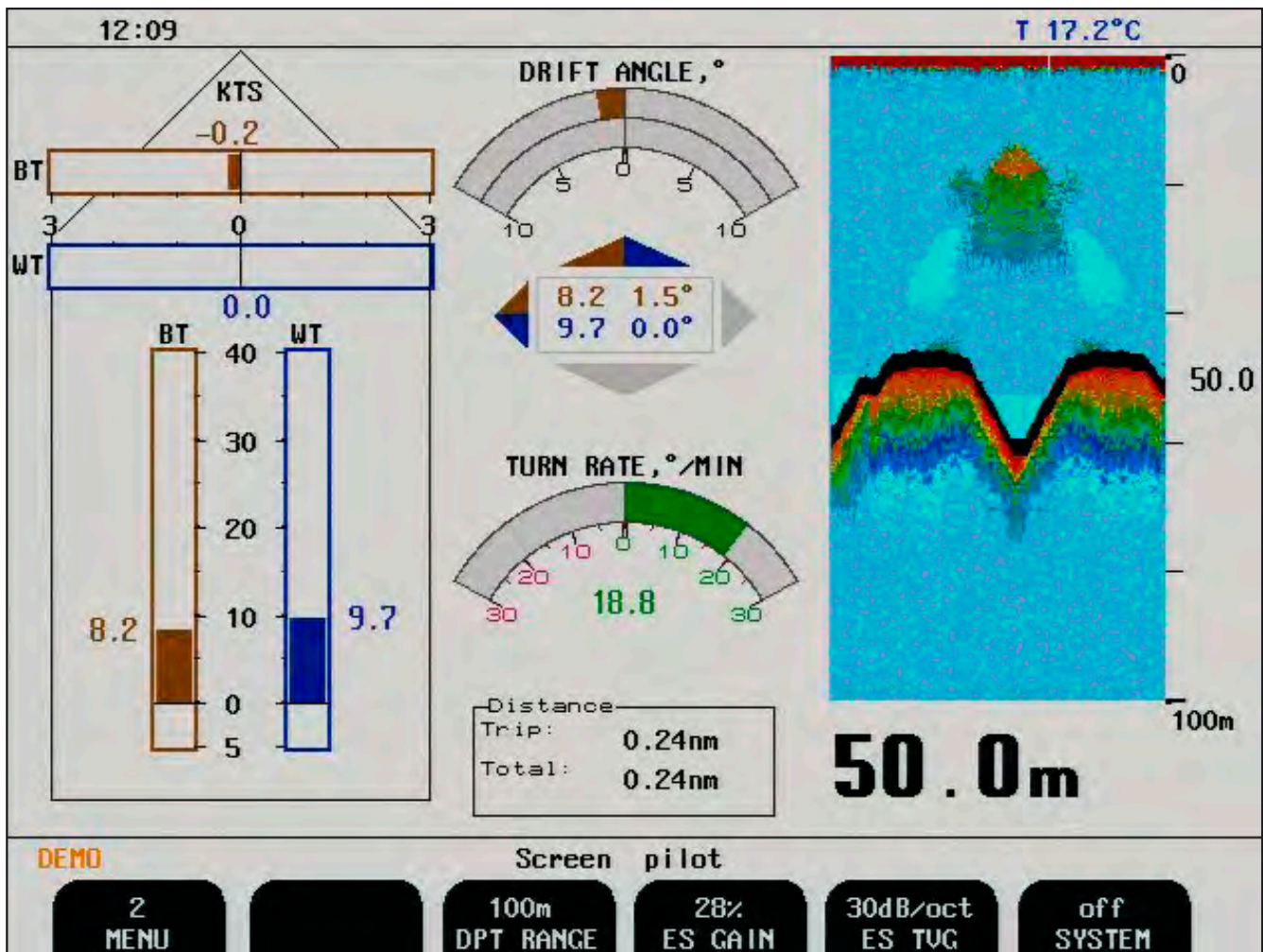

The various soft key menus are selected by pressing repeatedly the MENU button on the left side of the soft key menu. The number on the button indicates present active menu.

Screen pilot, Menu 2, ES functions.

Soft key	Name	Range/value	Default value	Description	Activate with hidden button
1	MENU	1 - 2	2	Menu 2 is selected.	
2				Not used.	
3	DPT RANGE	10 - 200 m	100 m	Echo sounder dept range.	
4	ES GAIN	0 - 100 %	28 %	Echo sounder gain	
5	ES TWG	5 - 50 dB/oct	30dB/oct	Echo sounder time variable gain expressed in decibel (dB)/oct. Note: "oct" is 100 m of range.	
6	SYSTEM	On/Off	On	Turn system off.	

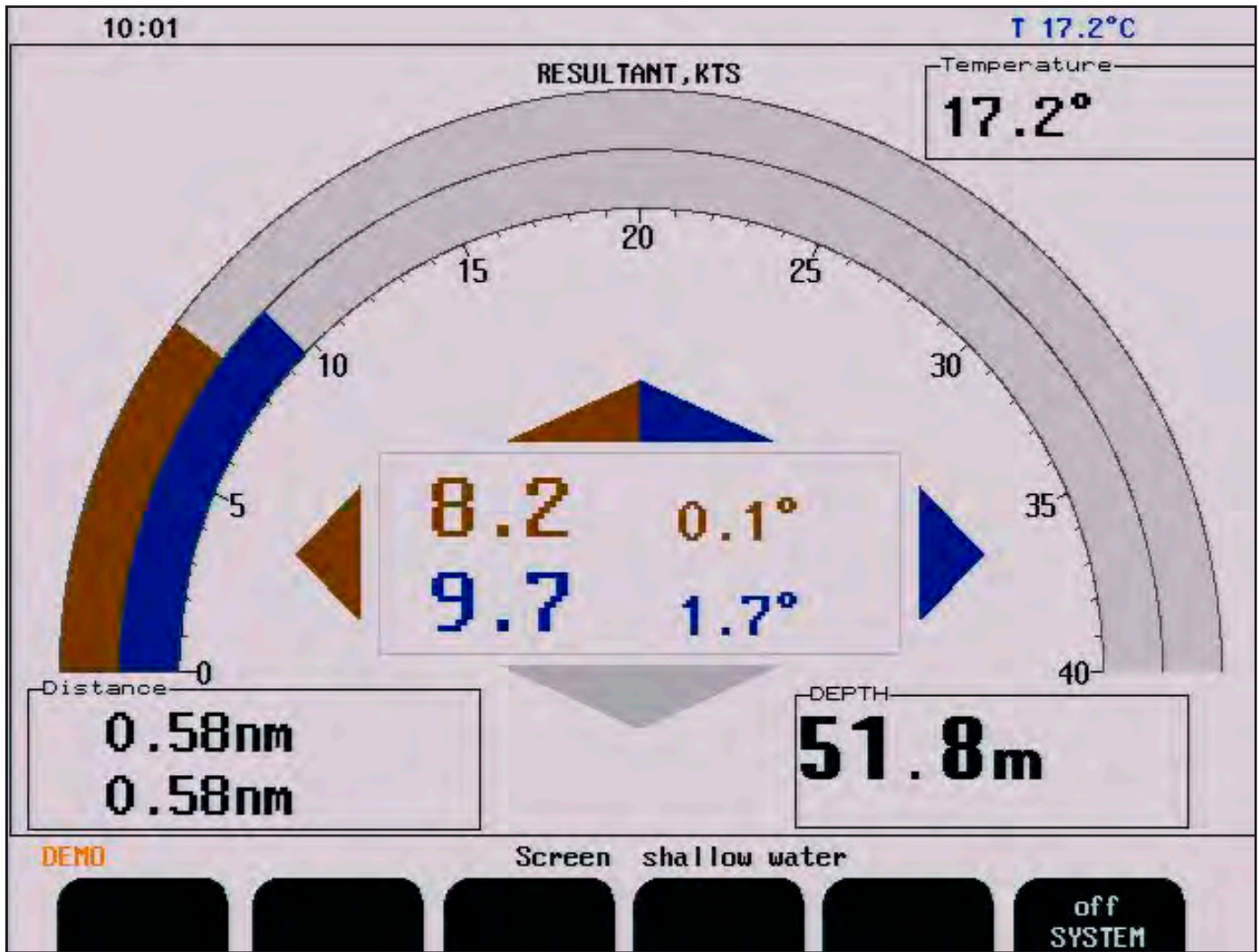

- Screen description “blue” shows resultant water speed and direction.
- Screen description “brown” shows resultant SOG (speed over ground) and direction. (Note: Value should be close to GPS value).
- Temperature is temperature in water.

Screen shallow water, (only in non docking version).

Soft key	Name	Range/value	Default value	Description	Activate with hidden button
1				Not used.	
2				Not used.	
3				Not used.	
4				Not used.	
5				Not used.	
6	SYSTEM	On/Off	On	Turn system off.	

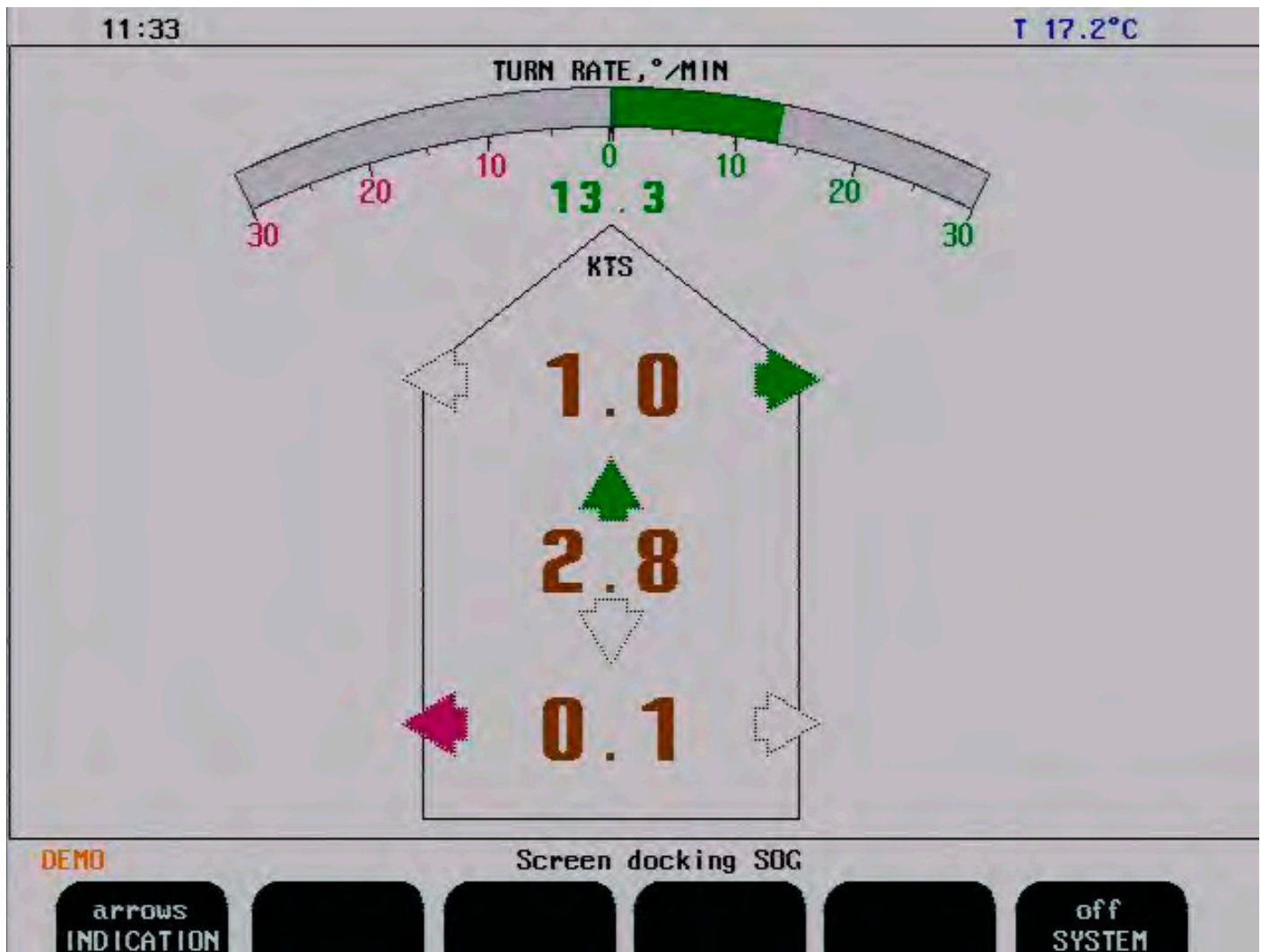

If bottom track is present, the docking screen will show measured longitudinal and transversal speed over ground (SOG) at fore and calculated speed at stern point. Speed indication may either be presented by values and arrows, or values and bars for directions.

Screen docking, arrow view (only in docking version).

Soft key	Name	Range/value	Default value	Description	Activate with hidden button
1	INDICATION	Arrows/bar graphs	Arrows	Arrow indication is selected.	
2				Not used.	
3				Not used.	
4				Not used.	
5				Not used.	
6	SYSTEM	On/Off	On	Turn system off.	

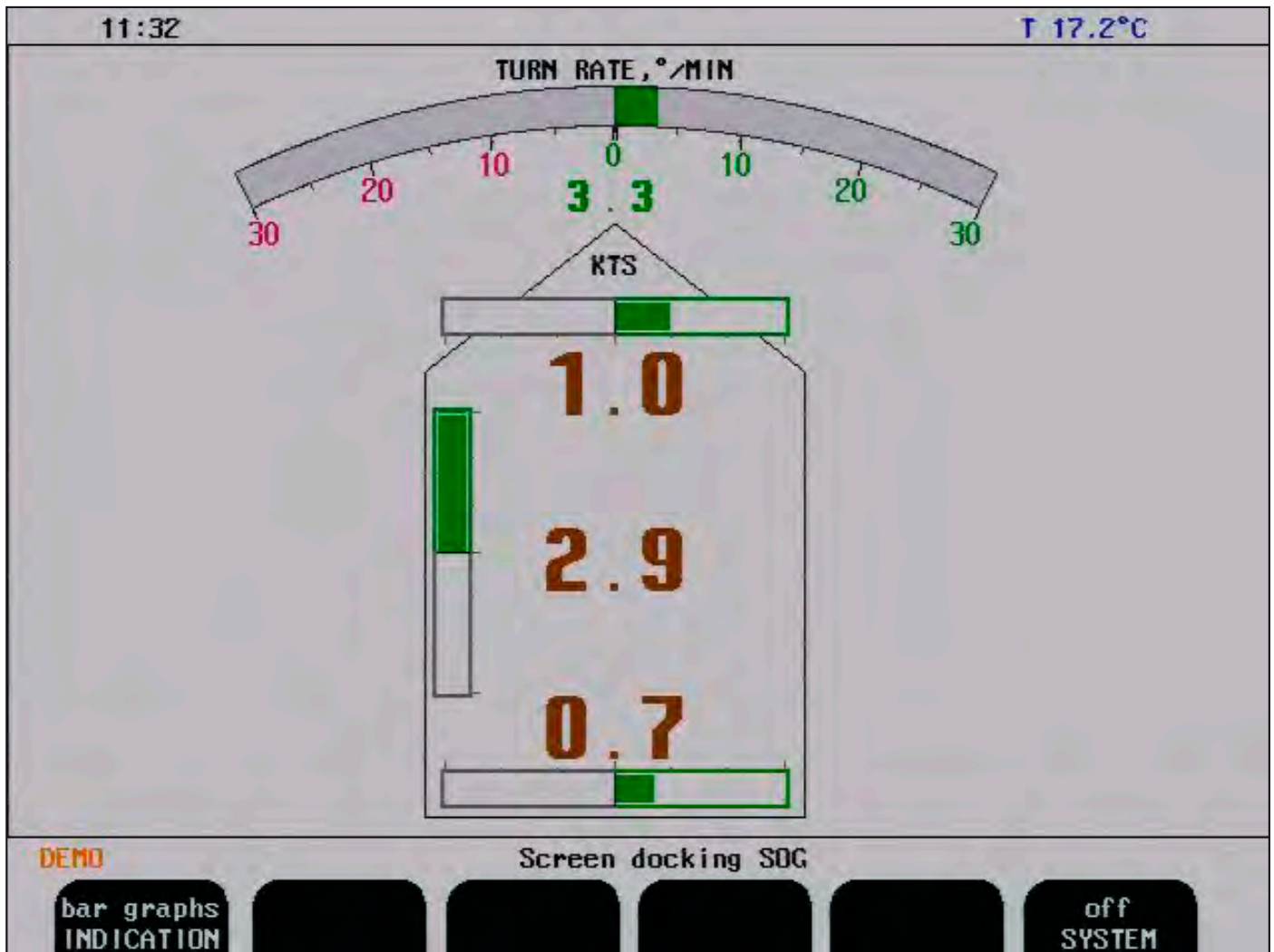

The screen above shows the result if ROT (Rate Of Turn) information is not available.

Screen docking, bar graph view (only in docking version).

Soft key	Name	Range/value	Default value	Description	Activate with hidden button
1	INDICATION	Arrows/bar graphs	Bar graphs	Bar graph indication is selected.	
2				Not used.	
3				Not used.	
4				Not used.	
5				Not used.	
6	SYSTEM	On/Off	On	Turn system off.	



Screen open sea, system.

Soft key	Name	Range/value	Default value	Description	Activate with hidden button
1				Not used.	
2				Not used.	
3				Not used.	
4				Not used.	
5				Not used.	
6	SYSTEM	On/Off	On	Turn system off.	

Note: This screen shows speed through water only.

Setup and Function Control Screens

Each of the operation screens contains a graphic picture and one or more menu sets configured on the 6 soft key buttons. Manoeuvre to the setup and function control screens by keeping the screen select button pressed and rotating the encoder in either direction. Turning the encoder clockwise cycle the screens as shown in figure below, and counter clockwise rotation cycles the screens in the opposite direction.

The screen layouts are outlined in the following pages. The various menus and soft key functions are described with each screen.

Setup and Function Control Screens

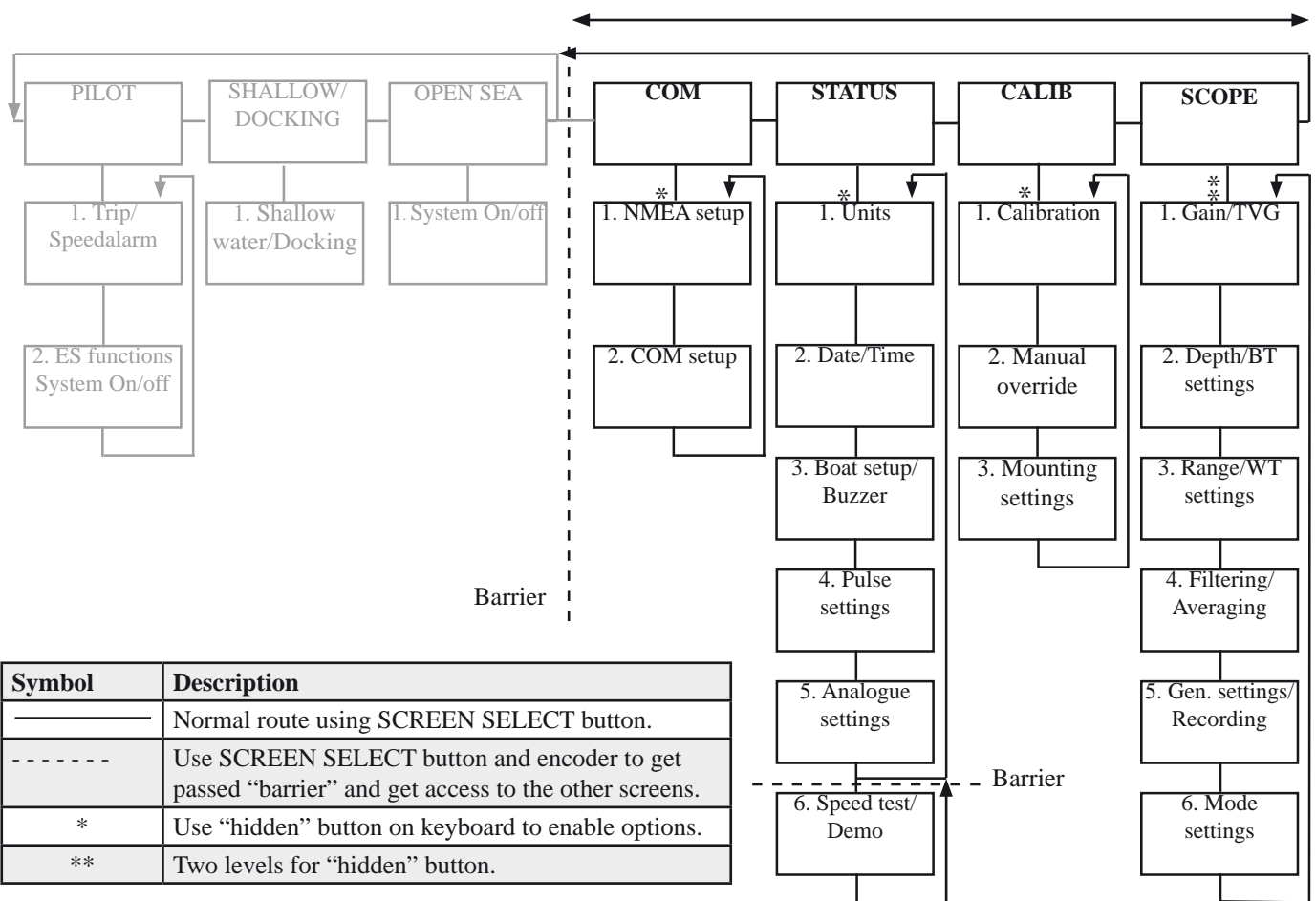

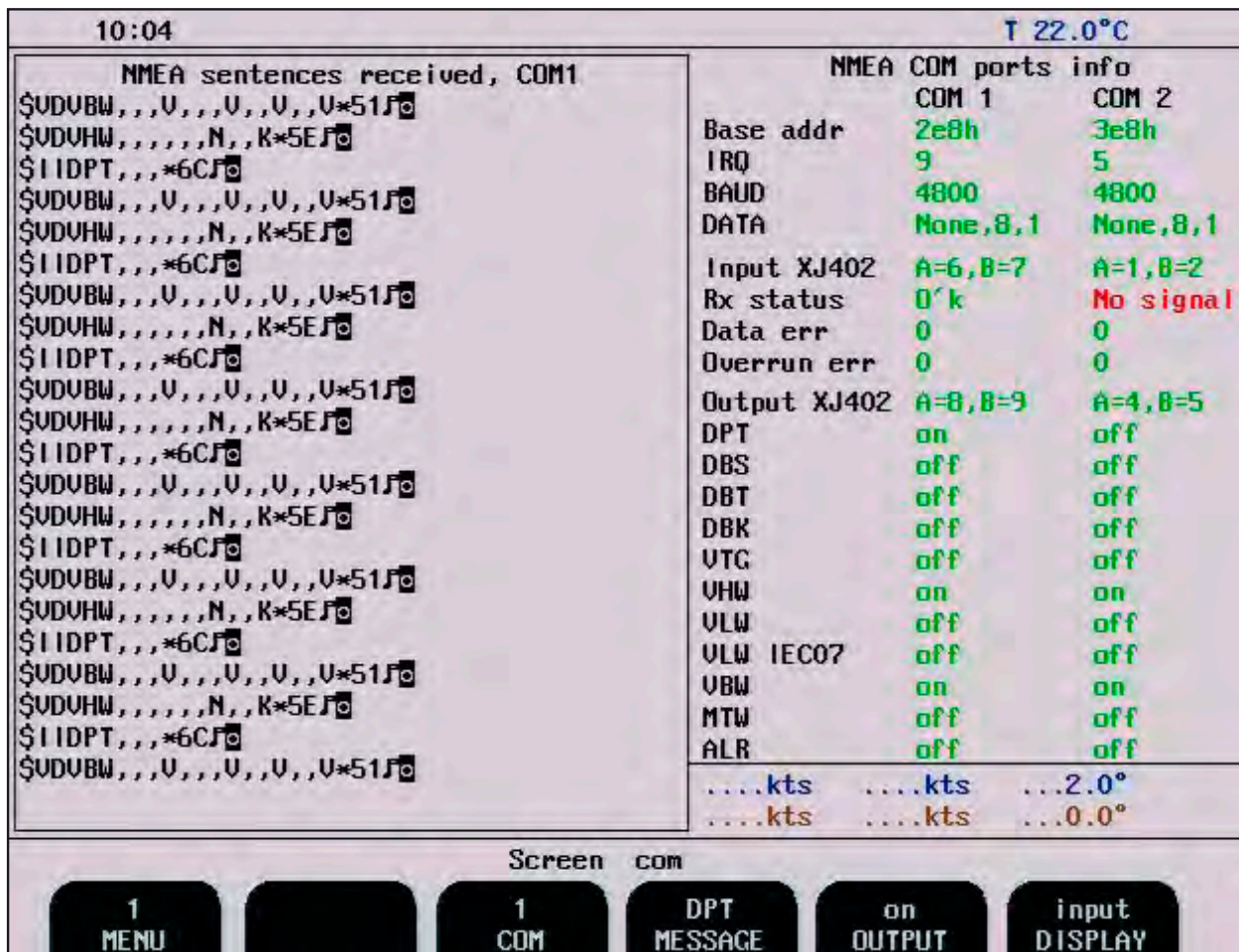

Note: The displayed messages corresponds to currently selected port.

Screen com, Menu 1, NMEA setup.

Soft key	Name	Range/value	Default value	Description	Activate with hidden button
1	MENU	1-2	1	Menu 1 is selected.	
2				Not used.	
3	COM	1-2	1	Select COM port. The ports can be configured to give different messages on the different ports.	
4	MESSAGE	DPT, DBS, DBT, DBK, VTG, VHW, VLW, VLW IEC07, VBW, MTW, ALR		NMEA message selector. Each message may be controlled individually by soft key 5. (See section NMEA setup, chapter 5 for more information).	
5	OUTPUT	On/Off	(See COM 2 on fig above)	Setting for the message in soft key 4. Note: To configure the serial output of the system, go through all the messages by pressing soft key 4 and set on/off value with soft key 5 to disable/enable a message as required.	
6	DISPLAY	Output/input/off	Input	Selects the information (received from the external source or transmitted by the DL850) to be displayed on the screen. Output: Signals transmitted from DL850. Input: Signals received from external source. Off: No signals displayed on screen.	

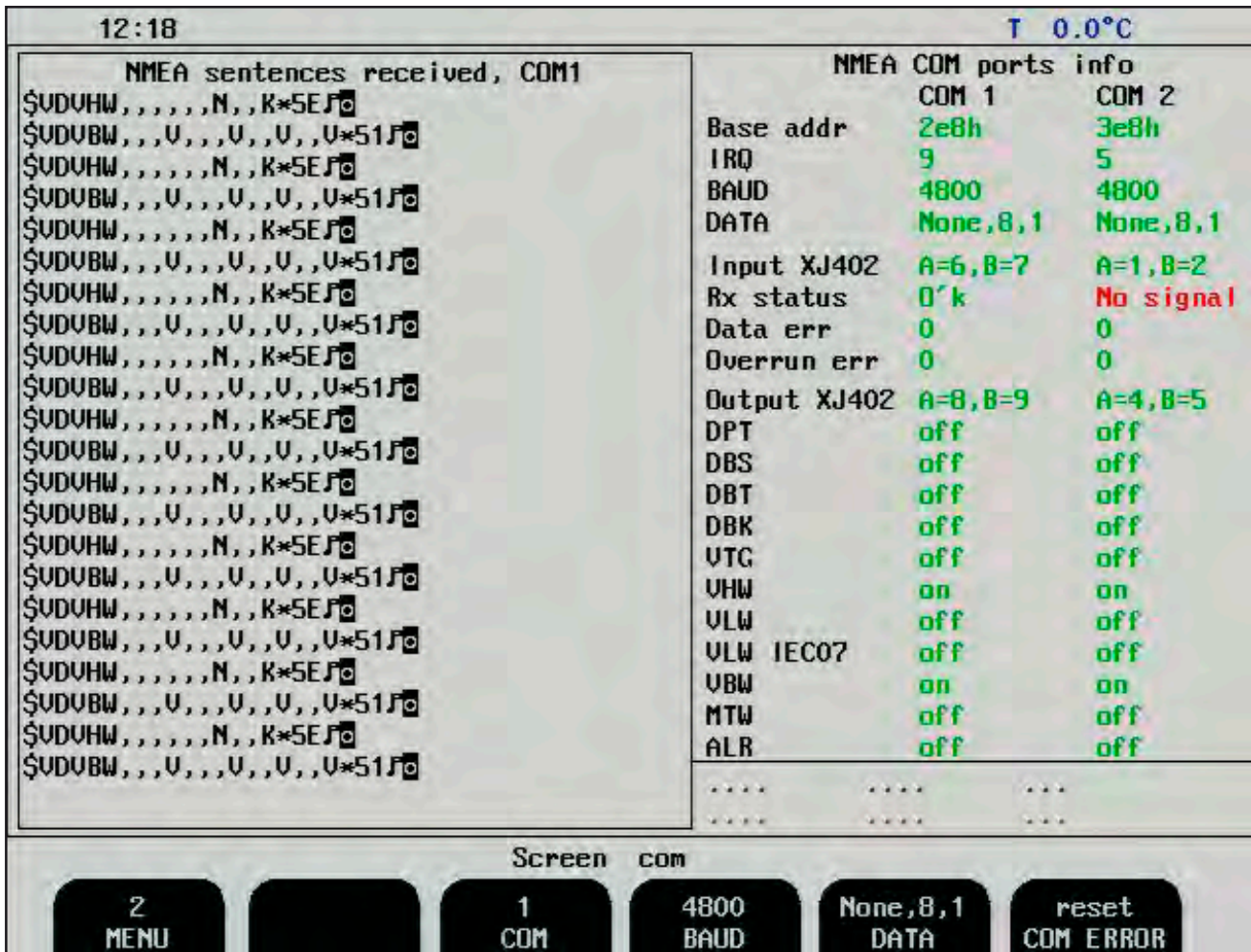

Screen COM, Menu 2, NMEA COM setup.

Soft key	Name	Range/value	Default value	Description	Activate with hidden button
1	MENU	1-2	2	Menu 2 is selected.	
2				Not used.	
3	COM	1-2	1	Choose COM port.	
4	BAUD	1200, 2400, 4800, 9600, 19200, 38400, 57600, 115200	4800	Baud rate for chosen COM port.	
5	DATA	None-7-1, Even-7-1, Odd-7-1 None-7-2, Even-7-2, Odd-7-2 None-8-1, Even-8-1, Odd-8-1 None-8-2, Even-8-2, Odd-8-2	None, 8, 1	Data format for chosen COM port. Parity, data bits, stop bits.	
6	COM ERROR	Reset		Reset field for COM errors. The program memorizes the latest occurred NMEA input error for further analysis. By using this soft key, it is possible to reset the error.	

NOTE: Baud rate and data settings apply to both input and output for selected COM port. Not recommended to use BAUD values above 38400 on terminals boards earlier than version E.

14 37 -18.4°/min 123.4° T 9.7°C

NMEA sentences received, COM1	NMEA COM ports info		
	COM 1	COM 2	
\$WIMWD,93.2,T,92.8,M,12.3,N,,*02	Base addr	2e8h	3e8h
\$SHEHDT,123.40,T*1B	IRQ	9	5
\$SHEHDT,123.40,T*FF	BAUD	4800	4800
\$SHEHDT,123.40,T	DATA	None,8,1	None,8,1
\$TIHDT,123.40,T*0B	Input XJ402	A=6,B=7	A=1,B=2
\$SHEROT,10.40,A*2E	Rx status	D'k	No signal
\$SHEROT,10.40,V*39	Data err	0	0
\$WIMWD,93.2,T,92.8,M,12.3,N,,*02	Overrun err	0	0
\$WIMWD,93.2,T,92.8,M,12.3,N,,*02	Output XJ402	A=8,B=9	A=4,B=5
\$SHEHDT,123.40,T*1B	DPT	off	off
\$SHEHDT,123.40,T*FF	DBS	off	off
\$SHEHDT,123.40,T	DBT	off	off
\$TIHDT,123.40,T*0B	DBK	off	off
\$SHEROT,10.40,A*2E	UTC	off	off
\$SHEROT,10.40,V*39	VHW	on	on
\$WIMWD,93.2,T,92.8,M,12.3,N,,*02	VLW	off	off
\$WIMWD,93.2,T,92.8,M,12.3,N,,*02	VLW IEC07	off	off
\$SHEHDT,123.40,T*1B	VBW	on	on
\$SHEHDT,123.40,T*FF	MTW	off	off
\$SHEHDT,123.40,T	ALR	uff	off
\$TIHDT,123.40,T*0B		20.9kn	-0.6kn
\$SHEROT,10.40,A*2E		20.1kn	-0.6kn
			-1.8°
			-1.8°

DEMO Screen com

1 MENU	1 COM	DPT MESSAGE	off OUTPUT	input DISPLAY
--------	-------	-------------	------------	---------------

The following examples show how the system responds to errors in the NMEA input formats. Formats in red are rejected. See more informations about accepted formats in chapter 5.

Input NMEA message	Description	Format status
\$TIHDT,123.40,T*1B	Correct, accepted format with checksum.	Accepted.
\$SHEROT,10.40,A*2E	Correct, accepted format with checksum.	Accepted.
\$SHEROT,10.40,V*39	Correct, accepted format with checksum but invalid status symbol.	Rejected.
\$SHEHDT,123.4,T	Correct, accepted format without checksum.	Rejected.
\$SHEHDT,123.4,T*FF	Correct, accepted format with wrong checksum.	Rejected.
\$WIMWD,93.2,T,92.8,M,12.3,N,,*02	Correct, not recognised format.	Rejected.



The status screen contains information that will facilitate analysis and correction of several problems. All installation settings are displayed on this screen. See section for trouble-shooting for more information about typical status screen content.

Screen status, Menu 1, units.

Soft key	Name	Value/range	Default value	Description	Activate with hidden button
1	MENU	1 - 6	1	Menu 1 is selected.	
2	LANGUAGE	English		Not active.	
3	VESSEL SPD	knots, km/h, mi/h, m/sec	knots	Select speed unit.	
4	ES RANGE	meters, feet, fathoms, braccias	meters	Select depth unit.	
5	DISTANCE	nm, km, mi	nm	Select distance unit.	
6	SOUND SPD	m/sec, ft/sec, knots, km/h, mi/h	m/sec	Select sound speed unit.	

Note: See chapter 5, Start-up and system adaptation, for more information.



Screen status, Menu 2, date/time.

Soft key	Name	Range/value	Default value	Description	Activate with hidden button
1	MENU	1 - 6	2	Menu 2 is selected.	
2				Not used.	
3	YR.MONTH	00.01 - 31.12		Year and month setting.	
4	DAY	01 - 31		Day setting.	
5	HOURS	00 - 23		Hours setting.	
6	MINUTES	00 - 59		Minutes setting.	

Note: If time and date information are provided on the NMEA input, these will have highest priority and time and date soft keys are disabled (dimmed).

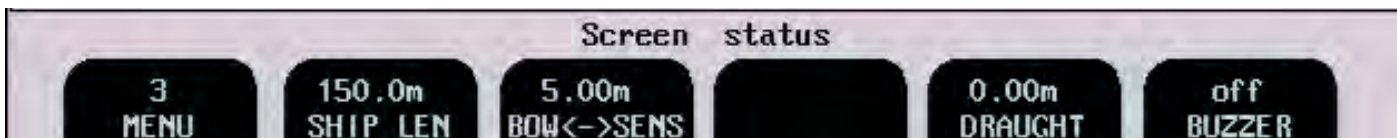

Screen status, Menu 3, boat setup/buzzer.

Soft key	Name	Value/range	Default value	Description	Activate with hidden button
1	MENU	1 - 6	3	Menu 3 is selected.	
2	SHIP LEN	0.00 - 500.0 m	150.0 m	Overall ship length (used for docking mode).	Yes
3	BOW<->SENS	0.00 - 500.0 m	5.00 m	Distance from bow to sensor (used for docking mode).	Yes
4				Not used.	
5	DRAUGHT	0.00 - 99.9 m	0.00 m	Echo sounder draught.	Yes
6	BUZZER	On/Off	On	Enable or disable the alarm buzzer.	Yes

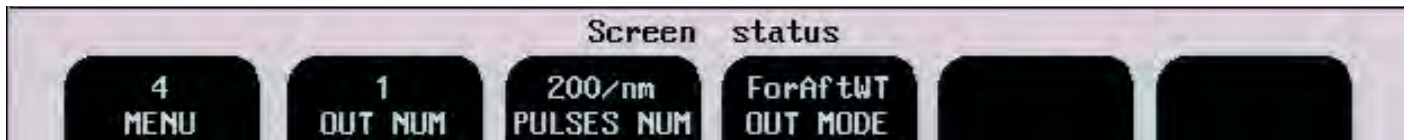

Screen status, Menu 4, pulse settings.

Soft key	Name	Range/value	Default value	Description	Activate with hidden button
1	MENU	1 - 6	4	Menu 4 is selected.	
2	OUT NUM	1 - 3	1	Pulse output channel to be configured by soft key 3 and 4 (Ch1, Ch 2, Ch 3).	
3	PULSES NUM	10/100/200/400/1000/nm	200/nm	Number of pulses per nautical mile at selected channel (soft key 2). Note: 1000/nm only on Ch 3 (OUT NUM 3).	Yes
4	OUT MODE	ForAftWT, LateralWT, ResultWT, ForAftBT, LateralBT, ResultBT,	ForAftWT	Type of speed value to be output at selected channel.	Yes
5				Not used.	
6				Not used.	

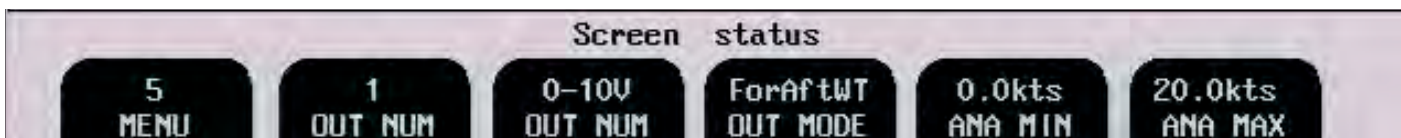

Screen status, Menu 5, analogue settings.

Sofkey	Name	Range/value	Default value	Description	Activate with hidden button
1	MENU	1 - 6	5	Menu 5 is selected.	
2	OUT NUM	1 - 3	1	Analogue output channel to be configured by soft key 3 - 6 (Ch1, Ch 2, Ch 3).	
3	OUT NUM	0 - 10 V 4 - 20 mA	0 - 10 V	Select output mode for this channel (soft key 2).	Yes
4	OUT MODE	ForAftWT, LateralWT, ResultWT, ForAftBT, LateralBT, ResultBT,	ForAftWT	Type of speed value to be output at selected channel (soft key 2).	Yes
5	ANA MIN	-48.6 - 48.4 kts	0.0 kts	Speed value, corresponding to minimum analogue value at selected channel. Corresponds to 0 V, 4 mA.	Yes
6	ANA MAX	-48.4 - 48.6 kts	20.0 kts	Speed value, corresponding to maximum analogue value at selected channel. Corresponds to 10 V, 20 mA.	Yes

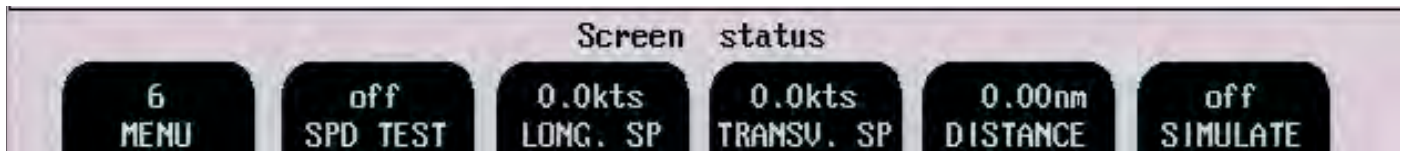

Screen Status, Menu 6, speed test/demo (simulate).

Functions described below can be used during commissioning period to test different DL850 outputs with constant, user adjustable speed values.

Note: Use the SCREEN SELECT soft key and the encoder to get access to Screen status menu 6.

Note: When the test mode is activated, this will be indicated by flashing “TEST” label in the lower left part of the screen. Simulator mode will be indicated with the label “DEMO”.

Soft key	Name	Range/value	Default value	Description	Activate with hidden button
1	MENU	1 - 6	6	Press soft key and turn encoder to select menu 6.	
2	SPD TEST	On/Off	Off	Toggling speed test mode.	Yes
3	LONG. SP	-40.0 - 40.0 kts	0.0 kts	Select test value for longitudinal speed.	Yes
4	TRANSV. SP	-5.0 - 5.0 kts	0.0 kts	Select test value for transversal speed.	Yes
5	DISTANCE	0.00 - 9999.99 nm	0.00 nm	Select test value for distance.	Yes
6	SIMULATE	On/Off	Off	Simulator on/off.	

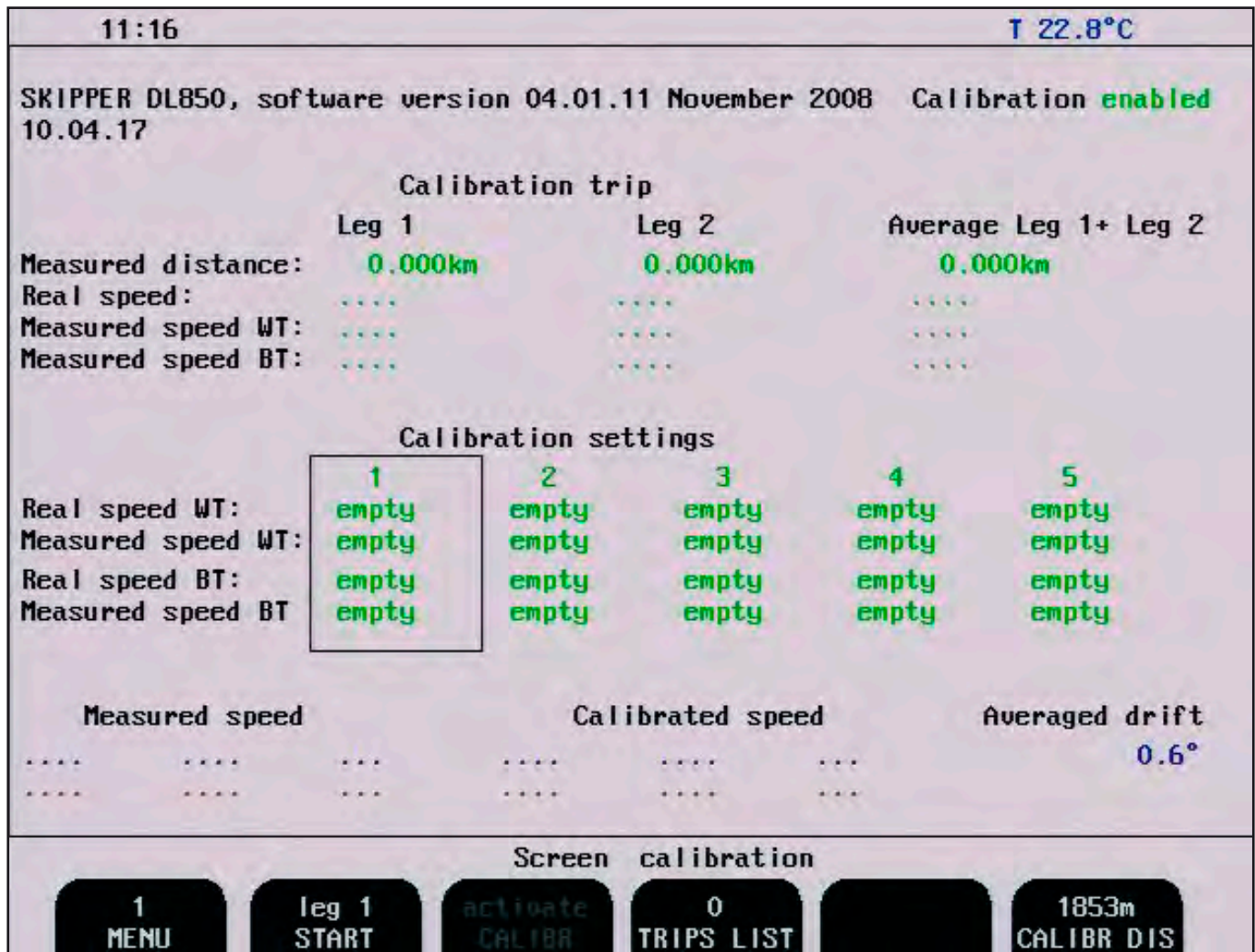

The various soft key menus are selected by pressing repeatedly the MENU button on the left side of the soft key menu. The number on the button indicates present active menu.

Screen calibration, Menu 1, calibration.

Soft key	Name	Range/value	Default value	Description	Activate with hidden button
1	MENU	1 - 3	1	Menu 1 is selected.	
2	START	Leg 1 start/finish Leg 2 start/finish	Leg 1	Used to start/finish test trip.	Yes
3	CALIBR	Activate		Used to move data, collected during test trip into calibration table.	Yes
4	TRIPS LIST	0 - 4	0	Used to list between different test trip data sets. Only one test trip is displayed on the screen at a time.	
5				Not used	
6	CALIBR DIS	100 - 10000 m	1853 m	Used to adjust length of the test leg.	



Screen calibration, Menu 2, manual override.

Soft key	Name	Range/value	Default value	Description	Activate with hidden button
1	MENU	1 - 3	2	Menu 2 is selected.	
2	CALIBR NUM	1 - 5	1	Number on the calibration data set currently available for adjustments. In the calibration table it is marked by the frame.	
3	WT REAL	0.0 - 48.6 kn	Empty	Real ship's water track speed (reference speed).	Yes
4	WT MEASUR.	0.0 - 48.6 kn	Empty	Water track speed, measured by the system.	Yes
5	BT REAL	0.0 - 48.6 kn	Empty	Real ship's bottom track speed (reference speed).	Yes
6	BT MEASUR.	0.0 - 48.6 kn	Empty	Bottom track speed, measured by the system.	Yes

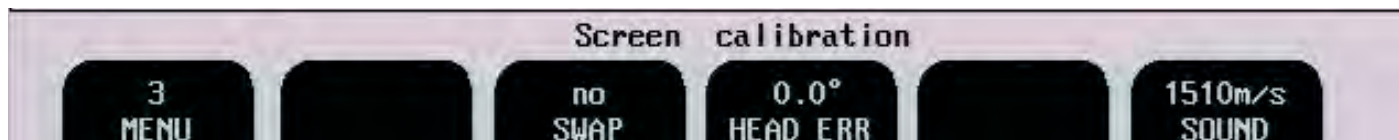

Screen calibration, Menu 3, mounting settings.

Soft key	Name	Range/value	Default value	Description	Activate with hidden button
1	MENU	1 - 3	3	Menu 3 is selected.	
2				Not used.	
3	SWAP	p - s, f - a, p - s /f - a, no	no	Transducer elements swap, p = port, s = starboard, f = forward, a = aft.	Yes
4	HEAD ERR	-30.0° - 30.0°	0.0°	Installation angular error correction.	Yes
5				Not used.	
6	SOUND	1400 - 1550 m/s	1510 m/s	Speed of sound in water.	Yes

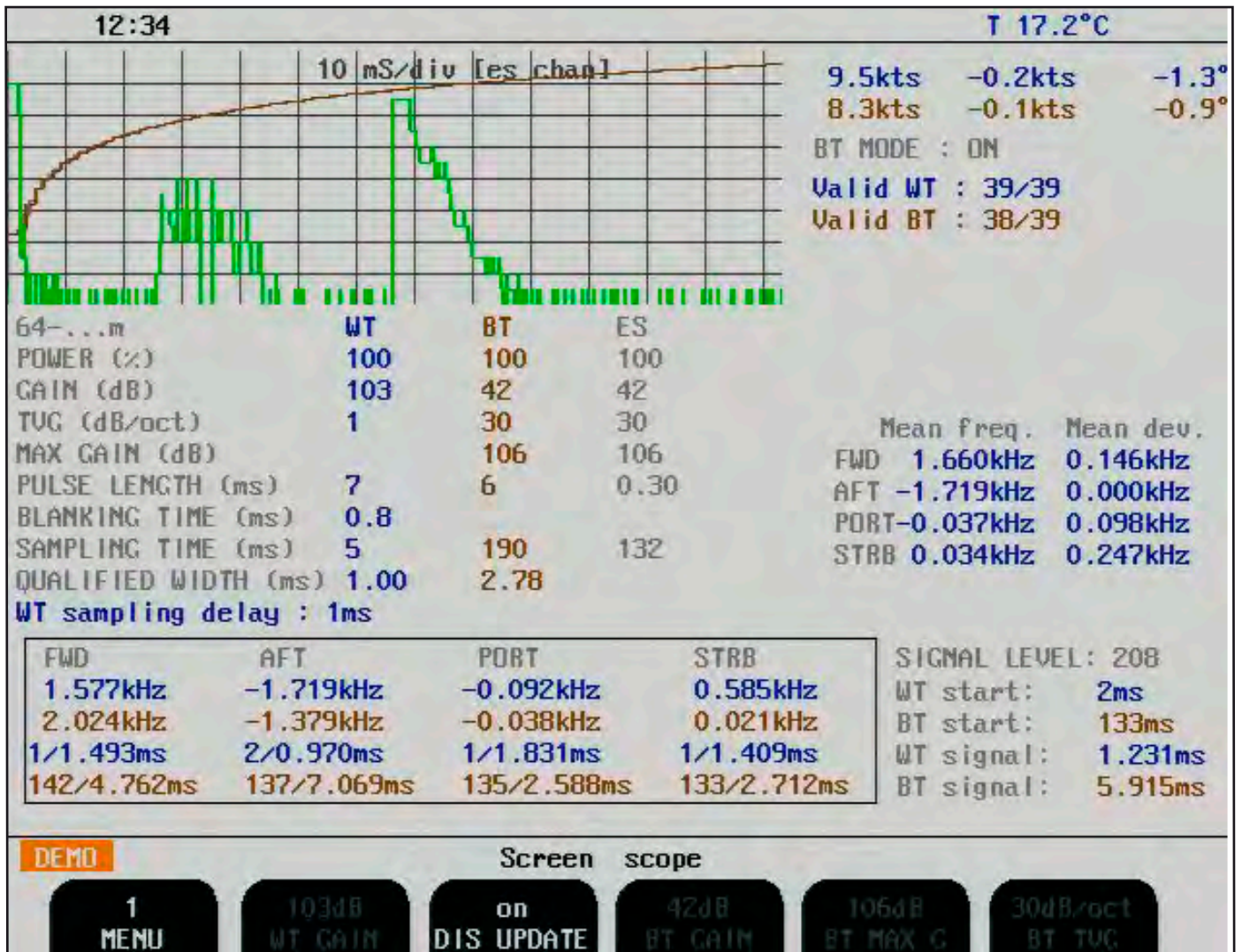

Diagnostic screen, see detailed information in chapter 7, trouble shooting.

Note: See Appendix 2 for detailed information about Screen scope settings.

Screen scope, Menu 1, display update.

Soft key	Name	Range/value	Default value	Description
1	MENU	1 - 6	1	Menu 1 is selected.
2				
3	DIS UPDATE	On/off	On	Toggle display update on/off.
4				
5				
6				



Screen scope, Menu 2, SL range.

Soft key	Name	Range/value	Default value	Description
1	MENU	1 - 6	2	Menu 2 is selected.
2	SL RANGE	1 - 5 m, 5 - 10 m, 10 - 15 m, 15 - 25 m, 25 - 40 m, 40 - 64 m, 64 ---- m,	1 - 5 m	Select speed log range for adjustments of the set of the transceiver parameters. During operation, the software will automatically activate the set of parameters which corresponds with the actual range (depth below transducer). Note: When the operator changes SL RANGE, the rest of the soft keys will change their values according to the currently set SL RANGE.
3				
4				
5				Not used.
6				

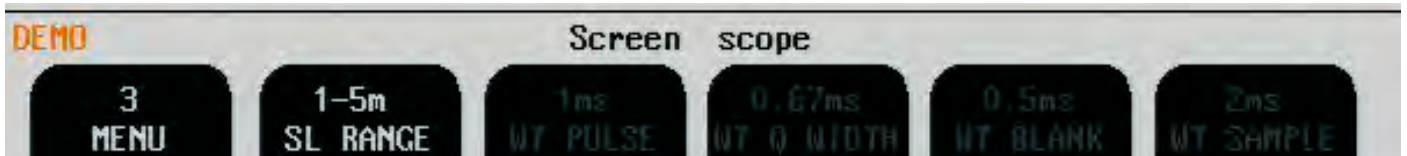

Screen scope, Menu 3, SL range.

Soft key	Name	Range/value	Default value	Description
1	MENU	1 - 6	3	Menu 3 is selected.
2	SL RANGE	1 - 5 m, 5 - 10 m, 10 - 15 m, 15 - 25 m, 25 - 40 m, 40 - 64 m, 64 ---- m,	1 - 5 m	Select speed log range for adjustments of the set of the transceiver parameters. During operation, the software will automatically activate the set of parameters which corresponds with the actual range (depth below transducer). Note: When the operator changes SL RANGE, the rest of the soft keys will change their values according to the currently set SL RANGE.
3				
4				
5				
6				



Screen scope, Menu 4, filter settings.

Soft key	Name	Range/value	Default value	Description
1	MENU	1 - 6	4	Menu 4 is selected.
2				
3				
4				
5				
6	MEAN VALUE	BT/WT	WT	Toggle between WT and BT for the information showing mean frequency and deviation for last 100 samples.



Screen scope, Menu 5, mean value BT/WT.

Soft key	Name	Range/value	Default value	Description
1	MENU	1 - 6	5	Menu 5 is selected.
2	DPT RANGE	10 - 200 m	100 m	Dept range to be used in the oscillogram window and conventional Echo Sounder picture.
3				
4				
5				
6				



Screen scope, Menu 6, system on/off.

Soft key	Name	Range/value	Default value	Description
1	MENU	1 - 6	6	Menu 6 is selected.
2				
3				
4				
5				
6	SYSTEM	On/off	On	Turn system off.

Principal Functions

Doppler Log Principle

The Doppler log works on the principle of detecting Doppler frequency shifts, i.e the phenomena of a perceived frequency being dependent on the relative speed of the emitting and receiving systems.

$$\Delta f = \frac{2v}{c} f$$

Observed frequency shift Δf ,
 Emitted frequency f ,
 Measured velocity, v ,
 Speed of sound in water, c .

A short burst of a known frequency is emitted into the water, and the frequency of the received echoes are measured. The difference between the emitted frequency and the received frequency makes it possible to calculate the relative speed. If the reflecting body is the bottom, the measured speed will be relative to ground. By measuring the reflections from the particles in a near water layer, a relative water speed may be obtained.

Bottom Track Characteristics

DL850 will try to acquire a bottom track when the depth is between 2 and ca. 120 m, depending on the bottom conditions. In this case, both bottom track and water track data will be acquired.

Water Track Characteristics

Water relative speed is measured at a depth of ca. 1 meter below transducer.

Docking Function - Option

Docking function is a feature for navigators which have a need of the transversal speed aft the ship. Instead of installing a second sensor aft, (which will normally cause problems due to turbulence under the sensor) the movement of the ship is calculated using the forward sensor and the gyro compass's rotation signal. Provided the ROT (Rate of Turn) signals fulfil the IMO standards (IMO Resolution A.526 (13)) and the Doppler sensor is installed and operating correctly, the transversal speed aft of the ship be calculated to the required accuracy of 0.2 kn.

The longer the vessel, the more accurate the requirement of the Doppler sensor. The accuracy of the sensor can be increased by increasing the averaging time of the system, or the size of the measurement sample (cell). The software will calculate the optimum averaging and cell size, based on the requirement spec of the system and set this as the default value. It is likely the averaging can be reduced to give a faster response as most systems have an actual performance better than the requirements. During installation, parameters for the ship length at waterline and distance between the bow and sensor must be entered into the log. These parameters are used for calculating the aft speed.

Echo sounder option

With the echo sounder option active, the depth will be shown as a thick black line in the echo sounder window, just showing the bottom contour. This depth is measured with the forward beam (tilted) and can not be used for approved navigation as approved echo sounder function.

Non-volatile Parameter Memory

The system contains memory to maintain installation and user parameters like unit of measurement, back light settings, etc. These parameters are kept in battery backed-up static RAM memory on the I/O board, and are automatically restored on power up. If the user parameters have never been set, default values are used. These values will be reset to default values when the “Master Reset” procedure is performed.

Fixed Key Functions

Screen Select

The screen select button facilitates selection of one of the 7 screen and soft key layouts. The 3 primary operation screens (Screen Pilot, Screen Docking/Shallow Water, Screen Open Sea) may be cycled by repeatedly pressing the screen select button. Access to the remaining 4 screens (Screen Com, Screen Status, Screen Calibration, Screen Scope) is through encoder operation. The screens are cycled in an endless, bidirectional loop, e.g. turning the encoder counter-clockwise, will “open” screen 7 after screen 1.

Backlight adjustment (brightness)

Backlight may be controlled by using the appropriate button and the encoder. Press the backlight button and rotate the encoder until a satisfactory setting is obtained, then release the button. The settings are maintained in the nonvolatile memory, and the last settings are restored on power up

Day/Night

Day/Night vision may be selected by pressing this button. These two modes differs by colour presentation, which are optimized for different ambient light conditions.

Soft Key Functions

Menu

If several menus are available, the leftmost soft key is always used for selecting the desired menu, i.e. soft key layout within a screen. The different screens have a different number of menus, and some of the menu functions may be available on more than one menu.

Trip Reset

This soft key is used to reset the trip distance log.

Sp(ee)d Alarm ▲

Set a speed high alarm limit.

Sp(ee)d Alarm ▼

Set a speed low alarm limit.

Alarm buzzer

The local alarm buzzer may be disabled, but the external alarm relay will always operate. The only way to disable the alarms completely, is to reduce the low speed alarm to zero and increase the high speed alarm to maximum range.

Alarm acknowledgement

When any alarm is activated, the alarm may be acknowledged by pressing any button. Alarm relay and audio alarm may be acknowledged by sending the “ACK” NMEA message from a alarm handling system, or by operating a remote button that shorts the INHIB2 and INHIBREF lines on the combo terminal board, (INHIB 2 = J100 pin 11, INHIBREF = J100 pin 9).

Clock and Calendar Settings

Manual clock and calendar adjustments are carried out in the screen status, menu 2. If a satellite receiver giving UTC messages is connected to the NMEA input, the clock and calendar will be automatically updated and manual adjustment is not available.

System On/Off

During normal daily operation, the system may be switched off from all primary screens. This operation does not disconnect the system from the power supply, but all power consuming components are switched off. The system may be switched on again by pressing any button.

3. User Maintenance

Transducer Maintenance

The transducers are virtually maintenance free, but occasional cleaning may be necessary depending on sea water conditions.

Operator Unit and Transceiver Unit Maintenance

The operator and transceiver unit contains no user serviceable parts, and requires no maintenance apart from occasional cleaning of the front panel. Please use a soft cloth and **no chemicals** except **cleaning alcohol**.

4. Installation

This chapter contains information related to installation of the Doppler speed log. Please ensure you perform all the following subsections:

- Installation of bottom parts/transducer.
- Operator unit installation.
- Turn on memory (backup battery jumper JP200).
- Interfacing.
- Selecting voltages.
- Connecting the transceiver unit (appendix 1).
- Checking (see chapter 5, start-up and system adaptation).

Handling warning

The Doppler system is a sensitive measuring device, all parts must be handled carefully. Please pay particular care with handling of the bottom parts and follow all instructions with regards to handling and installation.

Standard System Supply

A basic Doppler system consists of the following units (see overview drawings in appendix 1):

- Display/operator unit.
- Communication cable (if ordered, else yard supply).
- Transceiver unit.
- Sensor cable.
- Transducer (sensor).
- Bottom parts, usually a sea valve assembly.

For bottom part installation and placement, see separate manual.

Additional manuals are available from your supplier (contact information on cover page)

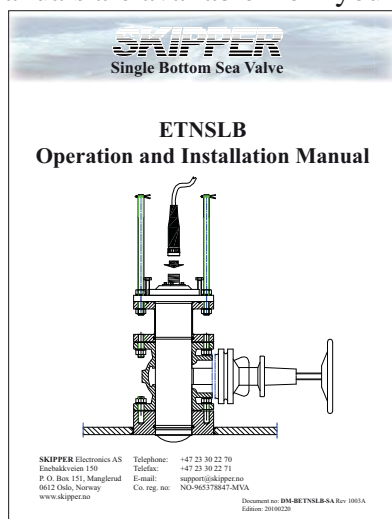

Transducer Installation

Location

- It is recommended to install the transducer in foreship.
- Optimal system operation is achieved by fitting the transducer as deep as possible on the hull.
- The transmitting surface of the transducer must be installed horizontal.
- Do not mount transducers close to the bow thruster propeller outlets, or aft of other hull installations (outlets, vents or other protruding details).
- It is necessary to select a part of the hull that is submerged under all load and speed conditions, and to avoid positions where air is trapped in heavy weather.
- If a flat, horizontal section is not available for transducer fitting, the shipyard must construct a suitable bed.

Protect the active element of the transducer and **do not paint the surface.**

Operator Unit Installation

Select a position to provide free view of the panel as well as easy access during operation and service. The operator unit may be mounted flush in a panel, on a wall or directly onto a bulkhead. See appendix 1, Installation Drawings that shows the operator unit along with the main installation dimensions. If the unit is to be flush mounted, the shown cut-out and recession depth dimensions must be observed.

Remember to leave room in front of the unit to open the door a full 90°.

Do not perform installation work with system power applied!

Cables are led through the appropriate cable glands as follows:

- The cable from the transceiver unit should normally occupy the left gland.
- The right gland is used for power supply connection.
- The centre ones are used for any interface signals connected.

Power supply may be either 115/230 V AC or 24 V DC. Power consumption is app. 50 W at 24 V DC and app. 70 W at 115/230 V AC.

If the AC power system is 115 V, the system must be prepared for 115 V by re-connecting the connectors J102, J103.

Fuses are shown in fig. 4.1 for 115/230 V AC and 24 V DC. These fuses are normal 5 x 20 mm slow blow glass fuses.

- 115 V AC: FS100, FS101: 1.0 A.
- 230 V AC: FS100, FS101: 0.5 A.
- 24 V DC: FS102: 3.15 A.

When the installation is complete, and power is connected to the operator unit, the appropriate power switch next to the power terminals is switched on. For daily operation, these switches may stay on

and the unit is switched off by pressing the “SYSTEM off” button. The unit is switched on by pressing any button.

Both 115/230 V AC and 24 V DC power may be connected and switched on at the same time. If one of these supplies shuts down, change over is automatic.

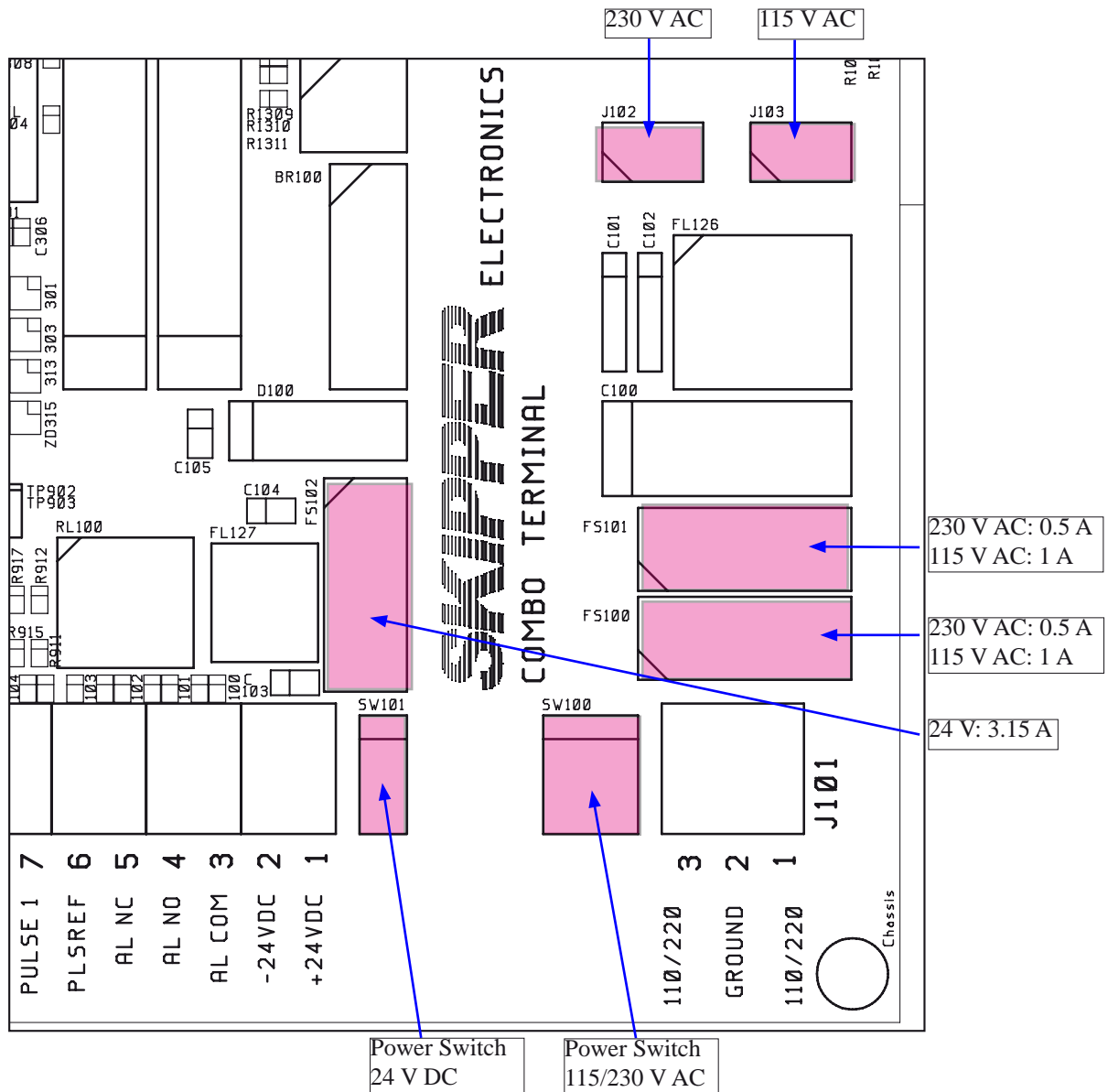

Fig. 4.1 Voltage selection connectors and fuses, Terminal Board.

AC Voltage selection

- Transformer primary to: J102 for 230 V AC and J103 for 115 V AC.
- Fit dummy plug on opposite connector for protection.

Fuses

- 230 V AC: FS100 and FS101 must be 0.5 A slow blow (default).
- 115 V AC: FS100 and FS101 must be 1.0 A slow blow.
- 24 V DC: FS102 must be 3.15 A slow blow (default).

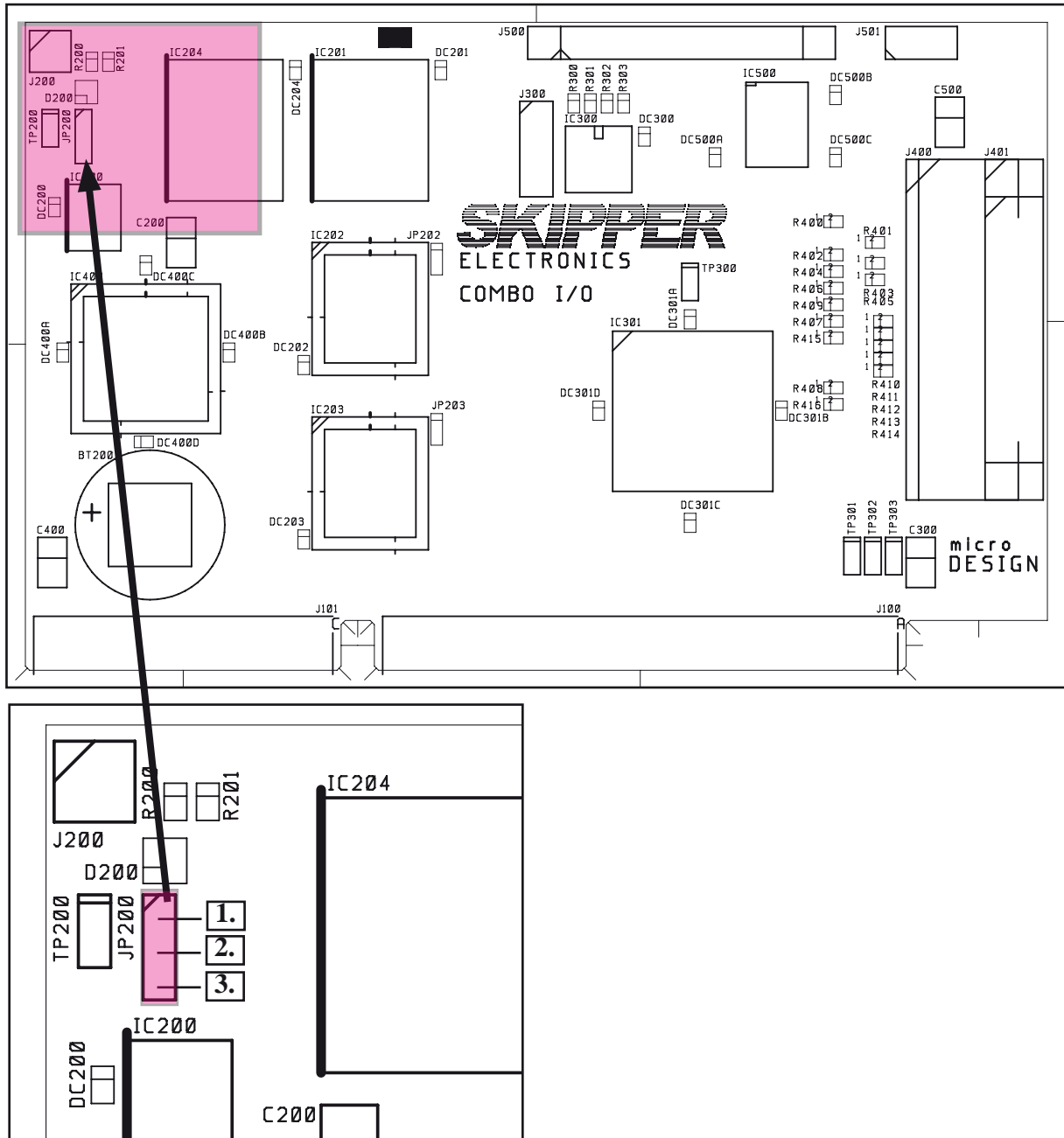

Fig. 4.2 Static Memory Battery Jumper, I/O Board.

Back-up Battery Jumper JP200

NOTE: After installation is complete and system power is applied, it is necessary to connect the static memory battery to provide power to the user parameters during system power failure.

Refer to Fig. 4.2 for the correct setting of the battery jumper “ON” position 2-3. This jumper should be set to the “OFF” position 1-2 only during extended unit storage periods. The battery is used only when no power is applied to the power terminal.

Note: If the system beeps 4 times on startup, the jumper is in “OFF” position or the battery voltage is low.

Interfacing

Alarm relay

An alarm relay is provided for interconnection to external alarm systems. This relay is normally energized, and is released by alarm conditions or power failure/power off. The terminals have the following significance:

Pin nr	Name	Description
J100 - 3	AL COM	Common terminal.
J100 - 4	AL NO	Normally open contact.
J100 - 5	AL NC	Normally closed contact (normal = "No alarm" condition).
J100 - 12	OPTDC	Separate power failure alarm +.
J100 - 13	OPTDE	Separate power failure alarm -.

Combined operational alarm and power failure alarm

Log Pulse Outputs

Pulse output terminals are as follows:

- Each group of pulse outputs are galvanically separated.
- All pulse outputs are opto couplers.
- The pulse rates and output modes are programmable in status screen, menu 4.
- Possible pulse rates are 10/100/200/400/1000 pulses per nautical mile. (1000 pulses Ch 3 only).
- Possible output modes are ForAftWT, LateralWT, ResultWT, ForAftBT, LateralBT, ResultBT.

Pin nr	Name	Description
J100 - 21	OPT3DC	Optocoupler 3, direction collector.
J100 - 20	OPT3VC	Optocoupler 3, velocity collector.
J100 - 19	OPT3EE	Optocoupler 3, common emitters.
J100 - 18	OPT2DC	Optocoupler 2, direction collector.
J100 - 17	OPT2VC	Optocoupler 2, velocity collector.
J100 - 16	OPT2EE	Optocoupler 2, common emitters.
J100 - 15	OPTVE	Optocoupler 1, velocity emitter.
J100 - 14	OPTVC	Optocoupler 1, velocity collector.

Pulse output is default set to water track in Fore/Aft direction (ForAftWT). For special purposes as ship maintenance or measuring of travelled distance in rivers, the pulse output may be set to give other types of speed such as ResultWT, ForAftBT or ResultBT. This option is protected and can be activated by using the hidden button as described in the chapter for calibration.

Inputs

Pin nr	Name	Description
J100 - 6	PLSREF	Reference for pulse inputs.
J100 - 7	PULSE 1	Not used.
J100 - 8	PULSE 2	Not used.
J100 - 9	INHIBREF	Reference for inhib inputs.
J100 - 10	INHIB1	Not used.
J100 - 11	INHIB2	Remote silence of alarm buzzer.

Short between INHIB2 (J100 pin 11) and INHIBREF (J100 pin 9) used for remote silence of alarm buzzer.

Analogue interfaces

The display unit is equipped with 3 analogue outputs to supply analogue repeaters or other equipment with analogue signals. The signals are galvanically connected to the cabinet ground. Standard range is 0 - 10 V or 4 - 20 mA. The velocity vectors and output modes are programmable from status screen, menu 5.

Pin nr	Name	Description
J100 - 22	ANAREF	System ground, common negative reference for analogue outputs.
J100 - 23	ANAOUT1	Analogue output 1.
J100 - 24	ANAOUT2	Analogue output 2.
J100 - 25	ANAOUT3	Analogue output 3.

NMEA interface

The NMEA output provides IEC 61162-1:2007(E) (NMEA 0183) format information for other equipment with NMEA 0183 inputs. Default setting is 4800 Baud, 8 data bit, 1 stop bit, no parity. Several messages may be selected on screen COM and the enabled messages are transmitted with maximum interval of 1.8 seconds.

The NMEA inputs accept alarm, position, rate of turn, heading and UTC time messages from various navigators and compasses.

One output can drive minimum of 10 standard NMEA 0183 inputs.

See section 5, Start-up and system adaption, for a complete list of transmitted and received messages.

Options

Repeaters/Slaves

Graphic CRT (VGA) or LCD displays or digital depth slave repeaters may be connected to the system. Most repeaters with speed can be used via the NMEA 0183 output. However, the manufacturer recommends: IR300 and CD401

External Interface Ports



5 x PG 13.5 cable entry 10-12 mm

Ground Stud

XJ402: NMEA ports D-SUB 9 pin female

XCN6: VGA terminal HDD-SUB 15 pin female

XCN3: Not used D-SUB 25 pin female

If required, the PG glands can be moved to other blinded holes. Extra holes are also available on back side of cabinet.

Operator Unit - Connecting External Equipment

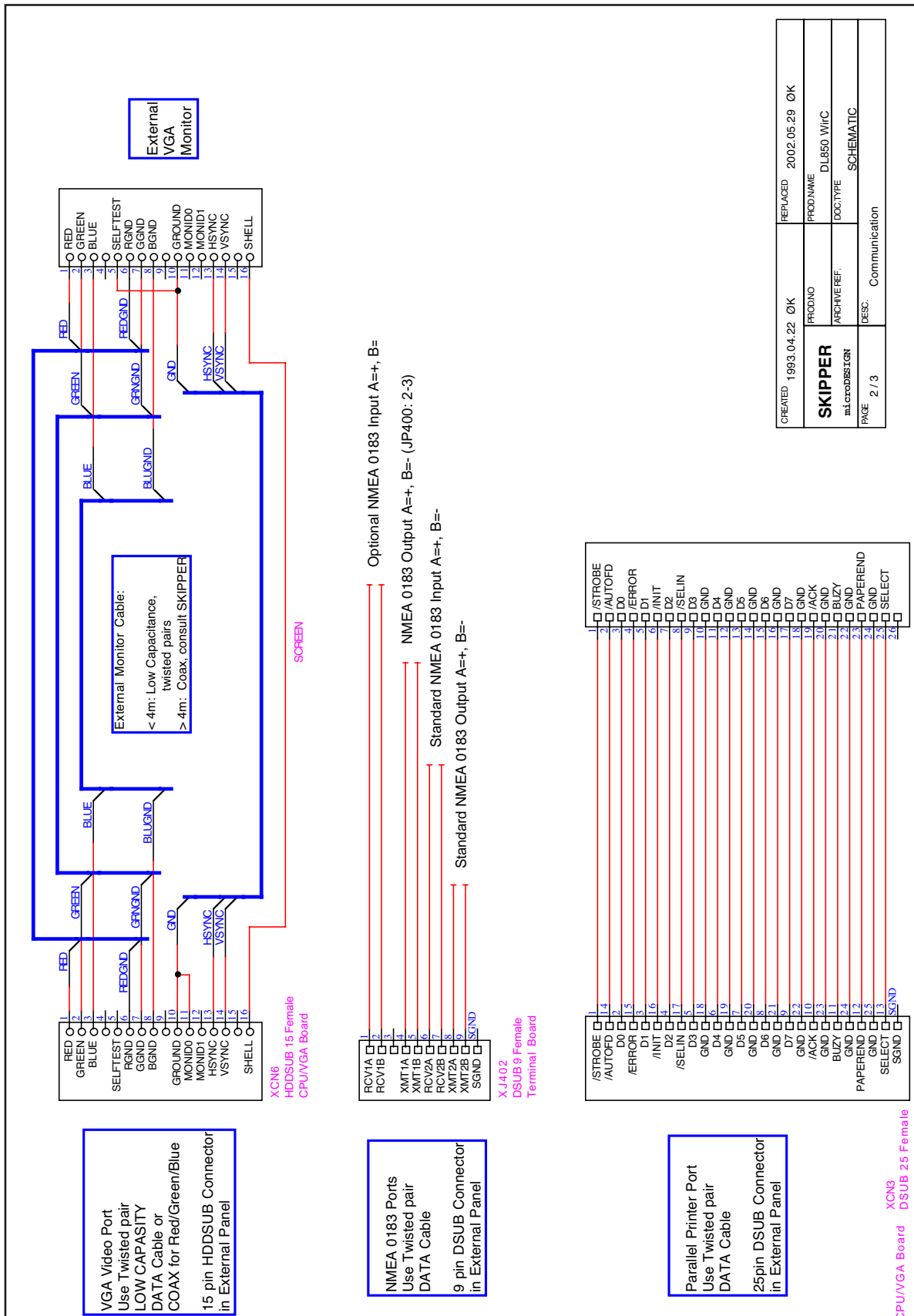

Misc I/O connections

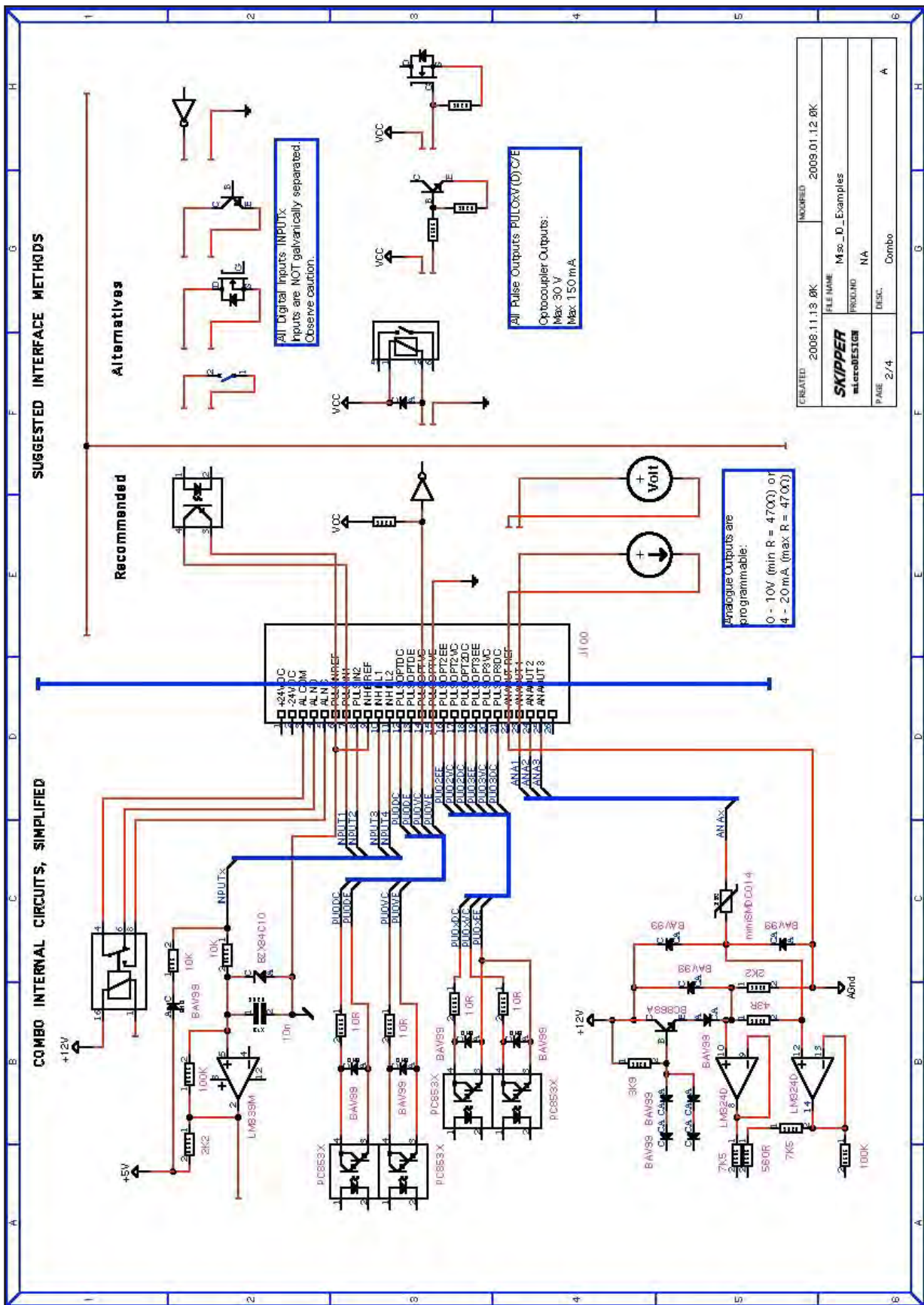

Fig. 4.6 Misc I/O connections

Alarm connections

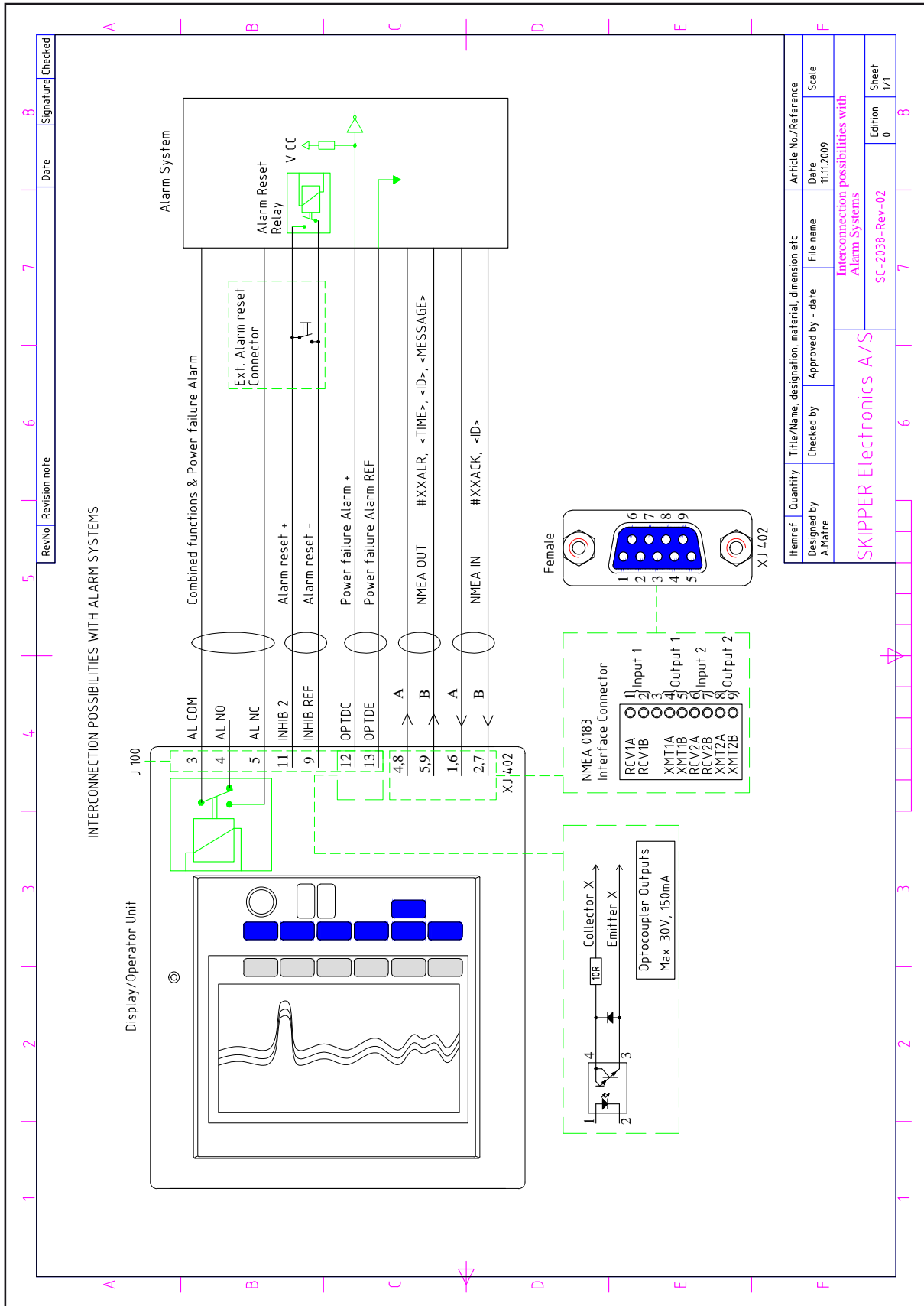

Fig. 4.7 Alarm connections

5. Start-up and system adaption

System Adaption

Analogue outputs and log pulse outputs range selection

From screen status, menu 4, it is possible to set number of pulses per nautical mile (10/100/200/400/1000) for the log pulse outputs. **Note:** 1000 pulses per nautical mile only on OUT NUM 3

Units of Measure

From screen status, menu 1, it is possible to select unit of measure for the screen.

Units of measure may be selected for:

- Vessel speed: knots, km/h, miles/h, m/sec.
- ES range: meters, feet, fathoms, braccias.
- Distance: nm, km, mi.
- Sound speed: m/s, ft/sec, knots, km/h, mi/h.

NMEA Setup

Screen COM is used for verification of received and control of transmitted IEC-61162-1 (NMEA) messages. The 4800 baud rate is the most common, but the baud rate may also be set to other values to interface with different kind of equipment. When a NMEA talker is connected to one of the inputs, all received messages will be displayed on the screen. If no messages are displayed, check the signal polarity and the baud rate. If messages are marked red, check message protocol. The following messages are accepted for input and interpreted by the program. The talker identifier is ignored.

Time

Day, month, year	ZDA,hhmmss.ss,xx,xx,xxxx,xx,xx*hh<CR><LF>
------------------	---

Position

Geographical lat/lon	GLL,llll.ll,a,yyyy.yy,a,hhmmss.ss,A,a*hh<CR><LF>
GPS position	GGA,hhmmss.ss,llll.ll,yyyy.yy,a,x,xx,x.x,x.x,M,x.x,xxxx*hh <CR><LF>

Rate of Turn

Rate of turn	ROT,x.x,A*hh<CR><LF> (Required for docking.)
--------------	--

Alarm

Acknowledge alarm	ACK,xxx*hh<CR><LF>
-------------------	--------------------

Heading

Heading, true, present	HDT,xx.x,T*hh<CR><LF>
True heading and status	THS,x.x,a*hh<CR><LF>

Composite

Loran C specific	RMA,a,xxxx.xx,N,xxxxx.xx,W,,xx,x,xxx,,*xx<CR><LF>
GPS, transit specific	RMC,hhmmss.ss,A,llll.ll,a,yyyy.yy,a,x.x,x.x,xxxxxx,,*hh <CR><LF>

Doppler log transmitted (talker) (IEC 61162-1:2007(E) (NMEA 0183) messages**Speed and distance**

Name	Description	Example
VTG	Course over ground and ground speed	\$VDVTG,,,,,x.x,N,x.x,K,a*hh<CR><LF>
VHW	Water speed and heading	\$VDVHW,,,,,x.x,N,x.x,K*hh <CR><LF>
VLW	Dual ground/water distance	\$VDVLW,x.x,N,x.x,N*hh<CR><LF>
VLW IEC07	Dual ground/water distance	\$VDVLW,x.x,N,x.x,N,x.x,N,x.x,N*hh<CR><LF>
VBW	Dual ground/water speed	\$VDVBW,x.x,x.x,A,x.x,x.x,A,x.x,A,x.x,A*hh <CR><LF>

Temperature

Name	Description	Example
MTW	Water temperature	\$VDMTW,x.x,C*hh<CR><LF>

Alarm

Name	Description	Example
ALR	Set alarm state	\$VDALR,hhmmss.ss,xxx,A,A,<Alarm message> *hh<CR><LF>

Depth

Name	Description	Example
DPT	Depth	\$IIDPT,x.x,x.x*hh<CR><LF>
DBS	Depth below surface	\$IIDBS,x.x,f,x.x,M,x.x,F*hh<CR><LF>
DBT	Depth below transducer	\$IIDBT,x.x,f,x.x,M,x.x,F*hh<CR><LF>
DBK	Depth below keel	\$IIDBK,x.x,f,x.x,M,x.x,F*hh<CR><LF>

Values will be preceded with sign as needed (e.g “-“ = Astern, Port).

*hh = Checksum.

Docking option parameter setup

Two parameters must be set (screen status, menu 3) to ensure that the docking option is showing the correct stern speed.

- **Sensor to bow:** Total length from sensor location to the bow.
- **Ship length:** Over all ship length, bow to stern.

6. Calibration procedure

Speed logs are calibrated in the factory to give reasonable results after installation, however installation and hydrodynamics vary from vessel to vessel. It is therefore necessary to calibrate speed logs once in place.

SKIPPER speed logs have two parameters that need to be corrected by calibration.

1. Angular sensor installation error (heading error).
2. Speed variations due to drag or mounting tilt.

1. Heading Error



The heading error parameter corrects for an angular offset in mounting. This offset will result in a rotation of the measurement axes. The resultant speed will be unaffected, but the longitudinal and transversal components will be incorrect. An offset will result in the vessel typically showing too much transversal speed, but may also result in speed calibration failing (i.e. initial calibration fails when further points are added). This offset will show itself as an averaged drift on the calibration.

Reducing Heading errors. Please follow the mounting instructions carefully to ensure the mounting angle is minimised

- **Sea valves** have a mark on the top flange (Figure 6.1).

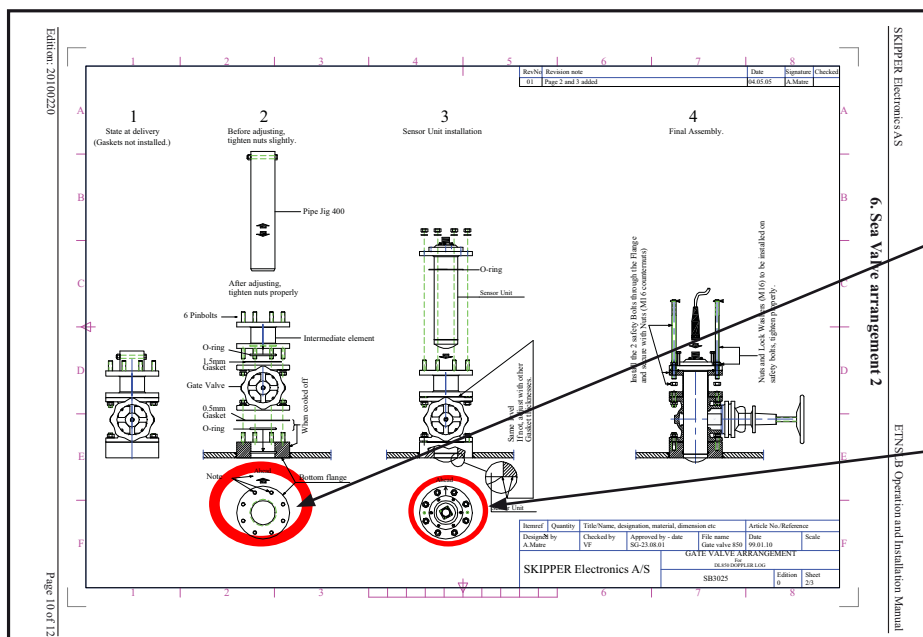
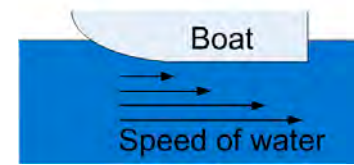

Figure 6.1 Sea valve alignment

Ensure that the bottom flange is welded with ahead between two screws as shown in the installation manual. Once assembled ensure the arrow on the sensor point ahead..

2. Speed variations due to drag or mounting tilt.

Every vessel will drag some water when it moves. This occurs over the whole hull. As you move further from the hull, the effect of the ships movement gets less. As the vessel moves at different speeds, the hydrodynamics of the vessel may change. In most cases the drag is even over the whole range of the vessel.



Speed logs that measure on the surface of the vessel (such as EML) are more affected by this factor than sensors that measure remotely (Doppler). The calibration variation is usually less on remote sensors.

As the calibration factors can vary at different vessel speeds, it is possible to calibrate several speeds. It is typically necessary with only one high and one low speed. Speed logs with speed over ground can be compared with GPS speed over ground in stable conditions. However speed through water measures the influence of currents on the vessel, which cannot normally be measured on any other system. It is therefore important that full calibration is performed at least once for speed through water.

Calibration routine:

As previously explained, there are two factors to be calibrated, heading error and speed. Speed over ground can be calibrated in two ways. Speed through water can be approximated, but should be calibrated by sailing on opposite courses to get an accurate value.

All calibration functions are located on the **Calibration** screen. In order to select this screen, press “screen select” button in the lower row of the panel buttons and while keeping it pressed, turn encoder until desired screen appears on the display.

Activation of the hidden menus

To avoid accidental access to the internal settings, all calibration functions are disabled during normal operation. In order to activate them, do the following:

- Open front door of the cabinet and find a “hidden” key on the component side of the keyboard PCB (upper/left corner of the PCB).
- Press key mentioned above and keep it pressed for 2-3 seconds, until “Calibration enabled” message is observed in the right/upper corner of the screen. The text on the soft keys will change colour from grey to white, which indicates availability of the corresponding functions.

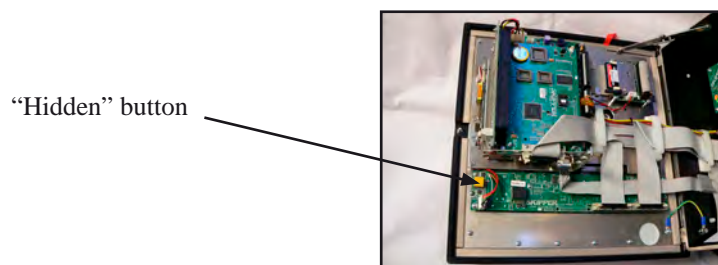

Note: After calibration is finished, disable access to the calibration functions simply by pressing the key again. Calibration mode is also disabled after a power recycling.

Step 1. Heading error correction:

The vessel sails a steady course in calm waters and the user reads the resultant angle (averaged drift). This is entered into the system using the **Head err** button and encoder on menu 3, and adjusted until the **averaged drift** angle is zero.

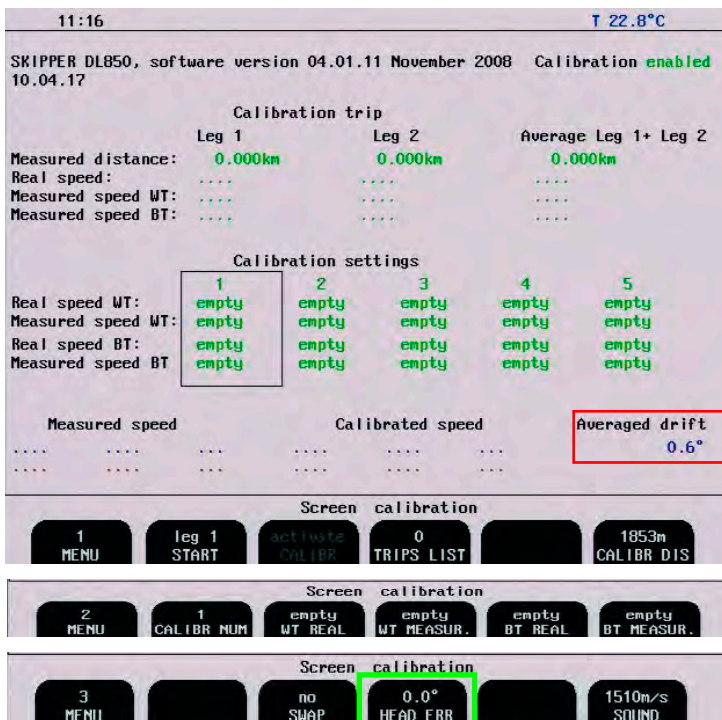

Step 2a. Manual speed calibration/adjustment:

The user enters speed values directly into the calibration table by comparing to other equipment, such as GPS. This can also be used to adjust values. Menu 2 allows you to enter the values directly. Press and hold an empty button will take the current values and place them in the table.

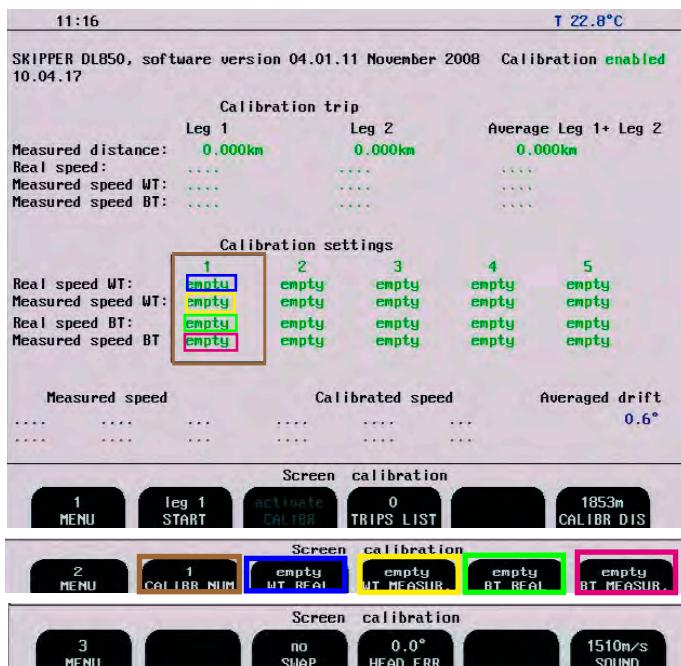

Screen calibration showing manual adjustment.

Placing values in the BT (Bottom Track) fields are valid. Doing this in the WT (Water Track) is not accurate. (Step 2b is recommended).

Step 2b. Semi Automatic calibration:

The vessel is made to sail a known distance and course in both directions, this to remove any water current factors from the speeds.

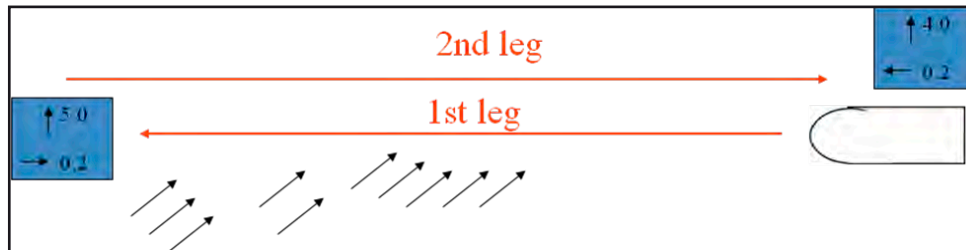

The 1st leg will show a different speed to the 2nd leg, however the direction changes in the second leg so that the average is correct.

The speed can be calibrated as follows:

1. Assuming you have performed step 1 “Heading Error”, plot a known distance on the chart. Enter this value into the **1.000NM CALIBR DIS** on menu 1.

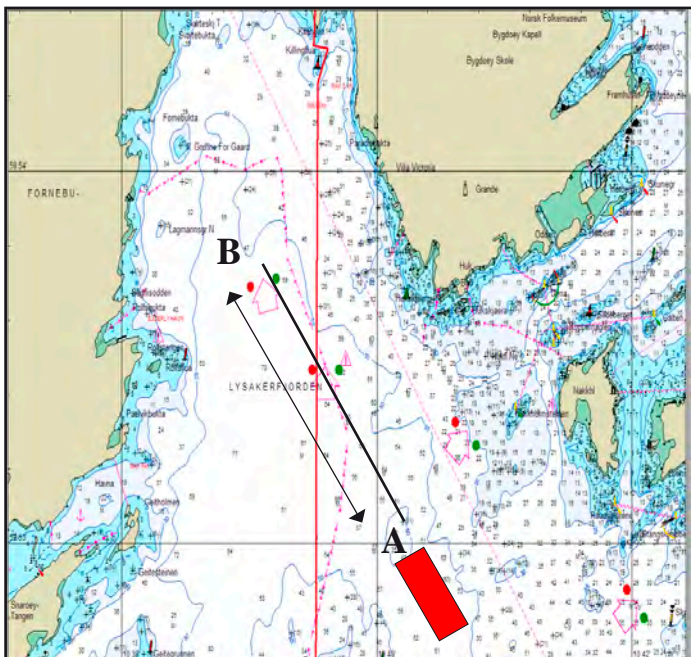
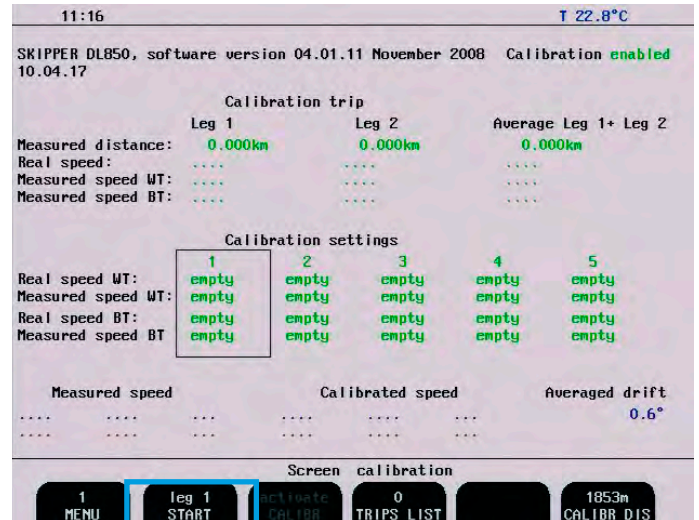
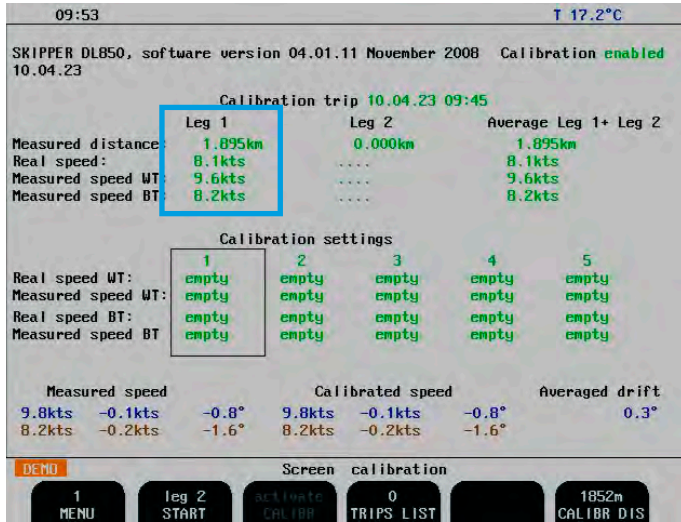

Figure shows plotting a calibration path on the chart.

The leg should take at least 5 minutes to sail (distance can be shorter when sailing slowly). Depth should be < 50 m to ensure that bottom track also calibrates correctly.

- Sail at a straight course in direction A to B and at a constant speed. When passing to point A, Press 'START leg 1' on menu 1. The button text will change to stop and a calibrating warning will show on the screen.



- The 'leg 1' measured distance will count up. You may ignore this. When you reach point B, press STOP. The system will then calculate the measured speed (from the measured distance and time) and the real speed (from the Calibr distance and time).
- Turn the vessel and repeat for leg 2 in the opposite

direction at the same speed. The results will show in the Leg 2 table. The average of the two legs will show in the final table. This is the correct calibration.

- If the calibration looks correct, you may select which calibration settings table to place it in, and transfer using the activate calibration button (which will be active if the calibration is within limits).
- You have now made a calibration point. We

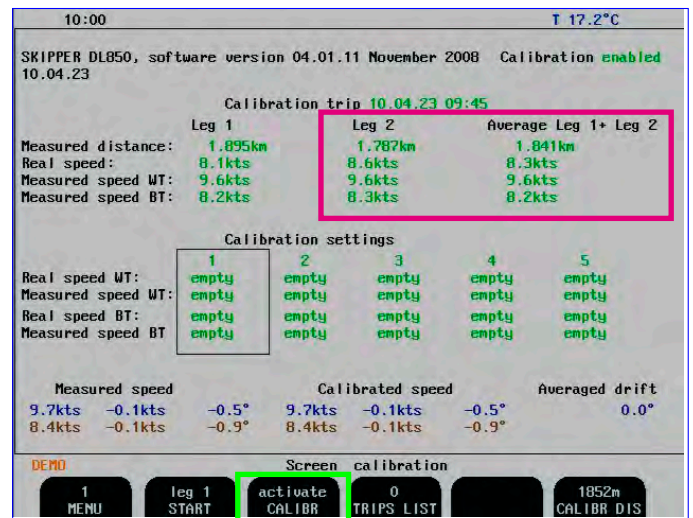
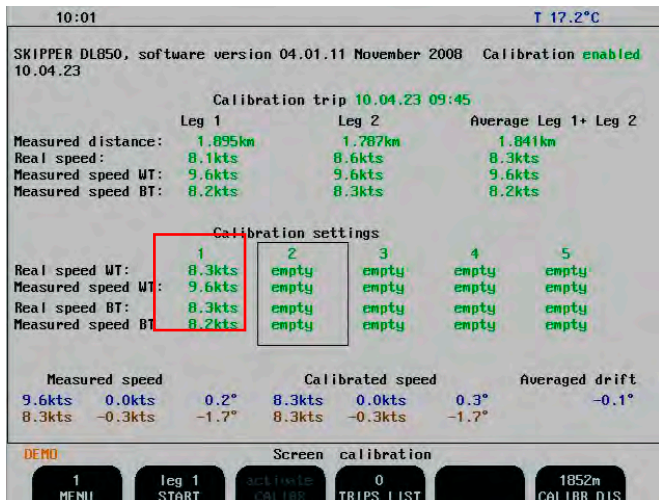

recommend a point at low speed (1-3 kn) and one at max speed (20 kn).

- Once calibrated, check the system at other speeds. If it is inaccurate, you may add more points (max 5).
NOTE: These values may be overwritten in some

software upgrades or if master reset is performed. We advise recording the values somewhere, just in case. Doppler systems typically have a calibration factor within 10 % i.e. measured 9 kn, real 10 kn.

7. Trouble Shooting

Symptom	Cause	Remedy
Basic System Integrity		
No picture on LCD screen.	<ol style="list-style-type: none"> 1. No AC or DC power to the system. 2. System is in standby mode. 3. Too low screen contrast. 4. Defective LCD module. 5. Voltage(s) out of range. 	<ol style="list-style-type: none"> 1. Check switches and fuses on the terminal board inside the DL850 cabinet. 2. Press any button on the panel. 3. Increase contrast settings or replace keyboard PCB. 4. Replace LCD module. 5. Replace terminal board.
Display backlight malfunctions. Display picture is hardly visible.	<ol style="list-style-type: none"> 1. DL850 initialization. 2. Defective backlight tubes. 3. Defective backlight inverter PCB. 	<ol style="list-style-type: none"> 1. Turn off power and wait for 5 sec before restart. 2. Replace backlight tubes. 3. Replace backlight inverter PCB.
Rotary encoder malfunctions.	<ol style="list-style-type: none"> 1. Defective encoder or interface. 2. SW problem. 	<ol style="list-style-type: none"> 1. Replace keyboard PCB. 2. Recycle power/do a "factory reset".
Panel buttons malfunctions.	<ol style="list-style-type: none"> 1. Defective buttons or interface. 2. One button stuck. 3. SW problem. 	<ol style="list-style-type: none"> 1. Replace keyboard PCB or I/O PCB. 2. Check key switch(es) or replace keyboard PCB. 3. Recycle power/do a "factory reset".
Loose user setup and calibration data.	<ol style="list-style-type: none"> 1. Battery backup not enabled. 2. Battery flat. 	<ol style="list-style-type: none"> 1. See chapter for jumper JP200 instructions. 2. Replace battery or I/O board.
Ambient t in status screen shows too high.	<ol style="list-style-type: none"> 1. Obstructed air flow. 2. Defective fan. 	<ol style="list-style-type: none"> 1. Check installations for obstructions of vent holes. 2. Replace fan.

Symptom	Cause	Remedy
Installation problems		
Status screen shows Link: No handshake. The LEDs on the power and transmitter PCBs inside transceiver cabinet never turns on.	<ol style="list-style-type: none"> 1. Transceiver unit power is off. 2. A pair HSOUTA/HSOUTB on the display side or HSINA/HSINB on the transceiver side is not connected properly to the terminals or wrong polarity of the connection. 3. Damaged communication cable. 	<ol style="list-style-type: none"> 1. Switch on the power in the transceiver unit or check fuses. 2. Check connection and polarity of the handshake lines. 3. Test/replace cable.
Status screen shows Link: No handshake. The LEDs on the power and transmitter PCBs are periodically turning on and off.	<ol style="list-style-type: none"> 1. A pair HSINA/HSINB on the display side or HSOUTA/HSOUTB on the transceiver side is not connected properly to the terminals or wrong polarity of the connection. 2. Damaged communication cable. 3. Bad connection of the transducer cable. 	<ol style="list-style-type: none"> 1. Check connection and polarity of the handshake lines. 2. Test/replace cable. 3. Check if the transducer is connected to the transceiver unit terminal according to colour diagram in appendix.
Status screen shows Link: No test data.	<ol style="list-style-type: none"> 1. No connection data lines to the terminal (XMITA/XMITB, RECEIVEA/RECEIVEB) or wrong polarity of the connection. 2. Damaged communication cable. 	<ol style="list-style-type: none"> 1. Check connection and polarity of the XMIT and RECEIVE data lines. 2. Test/replace cable.
Status screen shows Link: Test data error, or Link: Data error.	<ol style="list-style-type: none"> 1. Cable is not connected to ground or 0 Volt terminal. 2. Missing connection of one of the RECEIVEA/RECEIVEB wires on the display side or XMITA/XMITB on the transceiver side. 	<ol style="list-style-type: none"> 1. Check cable screen. 2. Check connection of data lines.
Status screen shows Link: Self test error, or Link: Bad checksum.	<ol style="list-style-type: none"> 1. Defective receiver PCB. 	<ol style="list-style-type: none"> 1. Replace receiver PCB.
Status screen shows Link: No data.	<ol style="list-style-type: none"> 1. Lock up of the transceiver micro controller due to overheat or strong source of noise close to transceiver unit. <p>Note: Display cabinet will restart process automatically.</p>	<ol style="list-style-type: none"> 1. Check environmental and noise conditions in the area.

Symptom	Cause	Remedy
Interface problems		
NMEA input signals are not listed in the NMEA input screen.	1. Wrong polarity of input signals.	1. Swap NMEA input lines.
NMEA input signals are listed in the NMEA input screen, but not accepted by the DL850.	1. DL850 initialization. 2. Irregular message mnemonic. Red: Not recognized.	1. Cycle DL850 power /do a “factory reset” after NMEA connection is established. 2. Check remote (talker) setup.
NMEA output signals are not accepted by the remote system.	1. Remote (listener) setup.	1. Verify correct remote (listener) setup.
Analogue output malfunctions.	1. Incorrect range settings.	1. Verify upper and lower limits in status screen.
Pulse output malfunctions.	1. Incorrect pulse frequency settings.	1. Verify pulse settings in status screen.
Power failure alarm output do not work.	1. Incorrect polarity. 2. Defective output.	1. Swap input lines. 2. Replace terminal board.
Operational alarm output do not work.	1. Incorrect terminal connection. 2. Defective output.	1. Check use of ALNC and ALNO terminals. 2. Replace terminal board.
Basic functionality		
Constantly wrong speeds or no speed.	1. Wrong calibration. 2. Damaged sensor.	1. Check calibration/re calibrate. 2. Replace sensor.
No bottom tracking.	1. Too deep water. 2. Too low gain or power settings.	1. See specifications for depth range. 2. Increase gain and power settings.
Bottom tracking is intermittent or erroneous.	1. Marginal gain or power settings. 2. Weather conditions. 3. Transducer installation faulty.	1. Adjust settings. 2. Try adjusting gain and power settings. 3. Check transducer wiring.
No echo gram contour.	1. Echo sounder is switched off. 2. Too low gain/TVG or power settings.	1. Echo sounder can be switched on in screen pilot. Note: Not recommended used if other echo sounders are in operation. 2. Increase gain/TVG and/or power settings.
Unrealistic aft speed values in docking mode.	1. Wrong setup of ship parameters.	1. Check installation values for over all length and bow to sensor.
No water track, just bottom track.	1. Flashing GPS-BT, too weak signals. 2. Not flashing GPS-BT, sensor failure.	1. Contact manufacturer, if problem persists. 2. Contact manufacturer.

Typical Status Screen Contents

The status screen contain information that will facilitate analysis and correction of several problems. Information from the status and scope screens should be sent by fax/E-mail with any report about functional disturbances.

12:54
T 17.2°C

SKIPPER DL850, software version 04.01.11 November 2008
 10.04.17 SW id:8c-c4-13-60 Frequency:540kHz

Display Voltages	Installation Settings	Installation Settings
+5VIO : 5,13V	Pulses ch1: 200/nm	Analogue ch1: 0-10V
+12VIO : 12,10V	Speed ForAftWT	Min limit: 0.0kts
+5UCPU : 5,05V	Pulses ch2: 200/nm	Max limit: 20.0kts
+12UCPU : 12,16V	Speed ForAftWT	Speed ForAftWT
Ambient t:Low	Pulses ch3: 200/nm	Analogue ch2: 0-10V
	Speed ForAftWT	Min limit: 0.0kts
	Language: English	Max limit: 20.0kts
	Vess. spd.un.: knots	Speed ForAftWT
	Dist units: nm	Analogue ch3: 0-10V
	Depth units: meters	Min limit: 0.0kts
	Sound spd.un.: m/sec	Max limit: 20.0kts
	Alarm buzzer: off	Speed ForAftWT
	Spd alarm ▲: 20.0kts	
	Spd alarm ▼: 0.0kts	

Link O'k
 Valid WT 100/100%
 Valid BT 93/100%
 Signal WT 25%
 Signal BT 49%
 False BT 0%

DEMO Screen status

1 MENU	English LANGUAGE	knots VESSEL SPD	meters ES RANGE	nm DISTANCE	m/sec SOUND SPD
-----------	---------------------	---------------------	--------------------	----------------	--------------------

If it is at all possible to cycle through the screens and observe this information, several assumptions may be made regarding operation of the DL850 system. Although some of the subsystems necessary for this basic system operation may still suffer from minor or intermittent operation disorders, the fact that it is possible to select and observe this screen, indicate correct operation of the following DL850 subsystems:

1. The CPU board is operating.
2. The keyboard and backlight PCBs are working.
3. The keyboard interface part of the I/O PCB is working.
4. The power supplies on the terminal board are basically working.

The information in the red box on previous page, shows the quality of the signals.

- **Link:** Shows the internal communication status between display unit and transceiver unit. Errors in this usually refer to a failure in cabling between the display unit and transceiver unit, but can also point to a failure inside the transceiver cabinet. (See “Installation problems” in table for more information).
- **Valid WT/BT:** Shows the quality of the returned Doppler echo. The percentage refers to how many returns are rejected due to bad acoustic or electrically noisy signals.
- **Signal WT/BT:** Shows the strength of the returned signals. This will vary depending on the water quality or bottom range.
- **False BT:** Indicates how often the system has detected an unreasonably large change in depth. This can indicate turbulence, objects in the beam, noisy sensors or interference from other systems.

Example: 67/67%. Double parameters show the longitudinal value followed by the transversal.

The other information on the status screen is a collection of information which may be observed and manipulated with the various screen soft key selections. As a reference, it will often be more convenient to observe the various settings together on this screen than to cycle from screen to screen to check on the soft key texts.

Typical Oscilloscope Screen Contents.

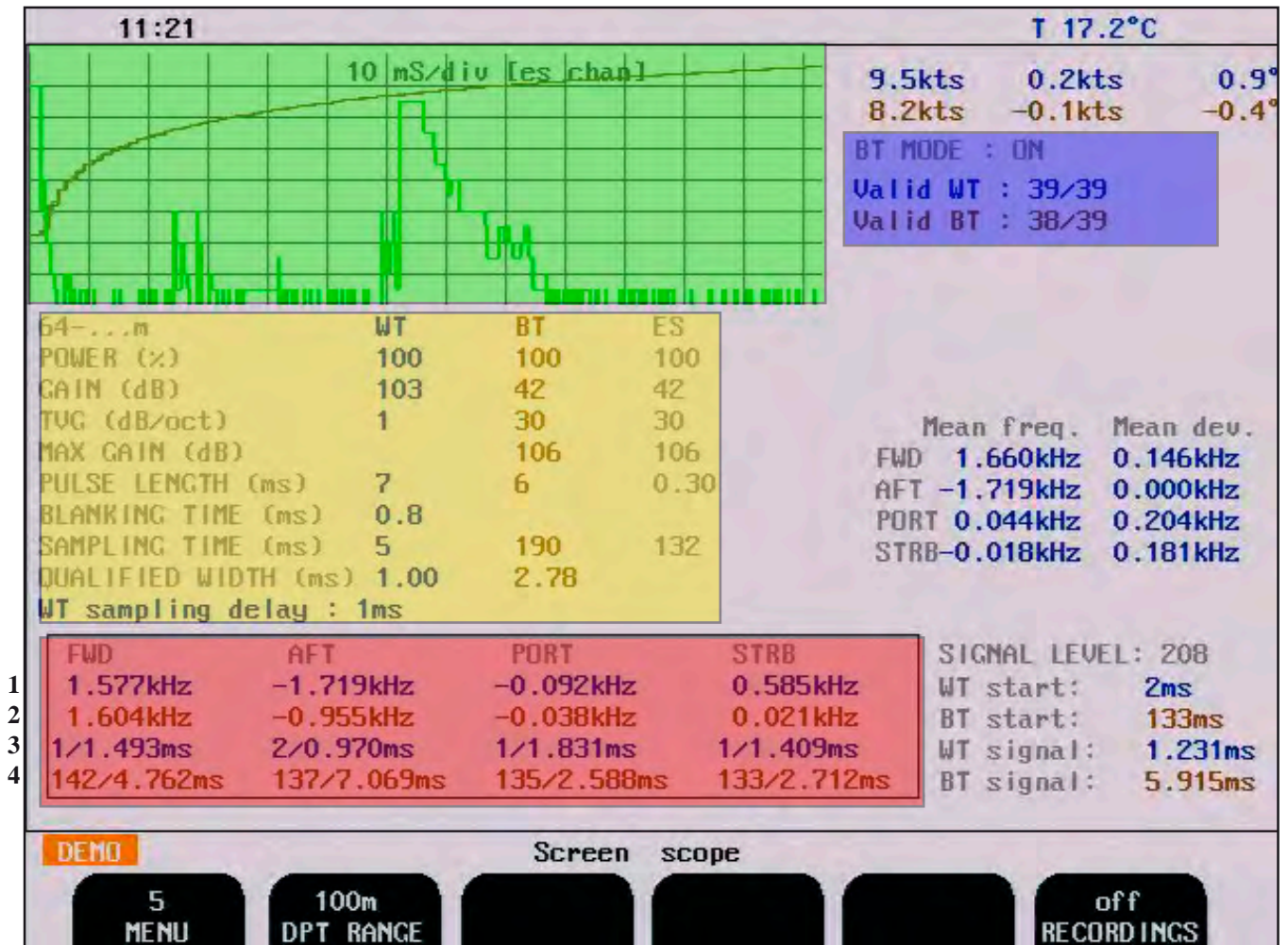

This scope screen show oscillograms from the various transducers. The horizontal axis represent time for the sound to travel down and back from an object or water layer. The vessel is located at the left edge of the grid, and the right edge represent the range. The vertical axis represent the magnitude of the received echo signal.

The scope screen allows the user to diagnose many problems within the system. The screen is split in the following areas.

The red area. The Doppler frequencies and quality parameters:

Each channel has a set of parameters

1. The first line shows the Doppler shift of the water track signal.
2. The second line shows the Doppler shift of the bottom track signal
3. The third line shows the waiting time between ping and sampling for the water track, and is fixed in time. The figure after the ” / “ shows the length of the return signal before it fades. This gives an idea of how much signal is reflected from the water particles. If this is very low, the water is very clean or the transmitted signal is weak.
4. The fourth line is as the third, however for the bottom track. The first number will vary with depth, and from these numbers you can get an idea of the slope of the bottom. It will also show if the bottom track

is triggering from something other than the bottom (for example a fresh water layer or fish). After the “ / “ shows the width of the bottom reflection. This will typically be longer than the transmitted ping and will get longer on sloping bottoms.

The blue area shows the number of pulses being used for the latest valid reading. it should be the same as the average number

The green highlighted section allows the user to observe the return signals from each channel in either water or bottom mode. This function is not available in this software version. If you need this please check the website for software updates.

The yellow highlighted section shows the optimised values depending on depth. The set of values for the present depth are displayed on the screen. These values allow you to compare the transmitted parameters, with the return signals (in red). These values are set after many hours of testing, and can be individually viewed on menus 2 and 3. The values can be changed, but this should happen under consultation with SKIPPER. (More information in appendix 2).

Failures

When a failure occurs with the system, this screen allows the user to perform diagnostics. A failure in the transceiver or sensor will be observable on this screen. Typically as follows:

1. Single beam failure: A single channel shows eg. “????” (question marks) in all frequency fields for that beam.

This can be a failure in the sensor head or in an individual channel on the transmitter. Check the scope (green) on the relevant channel.

Channel 1 = Fwd

Channel 2 = Aft

Channel 3 = Starboard

Channel 4 = Port

If one channel is noisy, the sensor element is probably defective. To ensure the failure is the sensor and not the transceiver, swap the transducer channels inside the transceiver cabinet on receiver connector J502. For example if the suspected error is on channel 3, swap channel 1 and 3. Repeat this procedure on transmitter connector J503. (See diagram of wiring in appendix 1, sensor cable connection)

Remember to turn off power at mains before attempting this!

The result of this will probably be that the “????” (question marks) will move to the new channel. This confirms that the fault is in the sensor or cable. If it does not move, the fault is within the transceiver cabinet (either transmitter or power card).

Take 3-4 pictures of the screen with a few seconds interval and send by E-mail to manufacturer.

2. All channels “????” and below (question marks) in red area.

If all channels are ????, the fault is most likely the power supply to the sensor. Check all terminals on J502 and J503 are fastened securely and correctly (See diagram of wiring in appendix 1, sensor cable connection).

If the temperature is also wrong (e.g. -4) the problem is most likely the sensor power supply. Measure the +- 9V power supply to the sensor (pins J502 p20-21 and 23-21) with and without the sensor wires attached. If the voltage drops considerably with the sensor power attached, the sensor is most likely faulty, although the power card is also suspected. If the problem is not identified here, refer to further instructions available as a data bulletin on the SKIPPER web site.

Master Reset Procedure.

In some cases the display cabinet may get “confused”, or the user has “adjusted” too much. Performing a master reset procedure will return all values to factory default settings

Before performing this, note your calibration settings, and setup for inputs and outputs as these will be lost during this procedure.

- Switch off the display unit using the internal toggle switch(es) and wait a few seconds.
- Then press down and keep pressed the soft key to the far right and far left (no. 1 and 6) in the upper row on the keyboard (soft keys).
- Turn “on” the display unit, and keep the two soft keys pressed down until the screen shows the normal picture. This may take as long as app. 30 seconds.
- You should now normally hear 4 “beeps”.

Note: You will now have to re-apply your settings for calibration, input/output and screen settings

8. Specifications

Dimensions

Transducer, 5 beam		
1 x 270 kHz, (Echo Sounder) 4 x 540 kHz	Mounting	Sea Valve ETNSLB 10 mm Single Bottom..
	Cable length	30 and 40 m.
	Weight	Sensor DL850S: 16 kg. Cable SC30: 16 kg. Cable SC40: 22 kg..
Transceiver cabinet	H x W x L	450 x 300 x 260 mm.
	Weight	app. 15 kg.
Operator unit cabinet	Height, front	340 mm.
	Width	320 mm.
	Depth	170 mm.
	Weight	app. 10 kg.
Operator unit cabinet		
	Cut-out for flush mounting	H x W: 324 x 304 mm.
	Corner radius	4 mm.

Functional Properties

Display	<ul style="list-style-type: none"> 150 x 200 mm LCD with adjustable backlight, 640 x 480 pixels.
Supply voltage	<ul style="list-style-type: none"> 115/230 V AC. 24 V DC (20-32 V)
Power consumption operator unit	<ul style="list-style-type: none"> 50 W at 24 V DC. 70 W at 115/230 V AC.
Speed alarms	<ul style="list-style-type: none"> High and low limits.
Calendar/clock	<ul style="list-style-type: none"> Year-month-day/hours-minutes-seconds (24 hour system).
Interface outputs	<ul style="list-style-type: none"> 10/100/200/400/1000 pulses per nautical mile. Analogue 4 - 20 mA and 0 - 10 V. IEC 61162-1:2007(E) (NMEA 0183) (RS-422). Alarm relay change-over contact, max. 24 V 300 mA. Output for VGA repeater.
Interface inputs	<ul style="list-style-type: none"> IEC 61162-1:2007(E) (NMEA 0183) (RS-422).
Languages	<ul style="list-style-type: none"> English.
Options	<ul style="list-style-type: none"> IR300 digital speed repeater. CD401 LR digital speed repeater.

Performance

Speed range	+/- 40 knots, (under favourable installation and sea conditions up to +/- 50 knots).
Depth range for water track	> 1.5 m.
Maximum roll angle	+/- 10 degrees.
Maximum pitch angle	+/- 5 degrees.
Depth range for bottom track	2 - 80 m.
Digital resolution	0.1 knots.
Speed and distance accuracy	0.2 knots or 2 %, whichever is greater.

Note: The performance widely depends on the hydro acoustic properties of the water column (aeration turbulence, depth, etc.), bottom conditions (sea-bed material, steepness of topography) and vessels rolling and pitching. These effects can lead to occasional failure of the system or to incorrect indication of speed and distance (unstable or too low values).

Note: The stated data for depth ranges and accuracy are not valid for unfavourable conditions. Since the speed accuracy depends on the sound speed (affected by salinity and water temperature), it is important to adjust (manually) this parameter for particular operation area, (screen calibration, menu 3).

Environmental

Transducer and transceiver cabinet

Operating temperature	0 - 50°C.
Storage temperature	-20 - 70°C.
Protection, transducer (wet side)	6 bar IP 68.
Protection, parts inside hull	IP 56.
Protection transceiver cabinet	IP 42.

Operator unit cabinet

Operating temperature	0 - 40°C.
Storage temperature	-20 - 70°C.
Humidity	10 - 90 % relative, no condensation.

9. Service

All service requests should be made to the local provider or representative. Contact details on title page

Adjustments and repairs should only be performed by qualified service engineers. Unqualified repair attempts will void the warranty.

Additional diagnostics aids can be provided by your local representative or by the manufacturer (contact details on title page). If service is required, please ensure the service centre is given:

- Serial and part number(s) of all affected parts.
- If possible, photos of screen calibration, screen status and screen scope.
- Sensor mounting type, (tank or sea valve).
- Vessel name.
- Problem description.
- Contact information for vessel bridge.

10. Appendix 1

Miscellaneous Installation Diagrams

Following diagrams, drawings and pictures are included:

- Fig. 10.1. Picture of transceiver unit showing PCB positions.
- Fig. 10.2. LEDs on PCBs in the transceiver unit.
- Fig. 10.3. System overview.
- Fig. 10.4. Interconnection diagram between the operator unit and the transceiver unit.
- Fig. 10.5. Interconnection diagram between sensor and the transceiver unit.
- Fig. 10.6. Dimensional drawing of transceiver unit.
- Fig. 10.7. Dimensional drawing of operator unit.
- Screen scope explanations.

For bottom part installation, see separate manual, supplied with bottom parts.

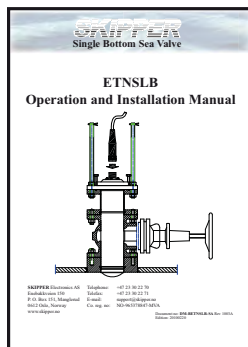

PCB positions in Transceiver Unit

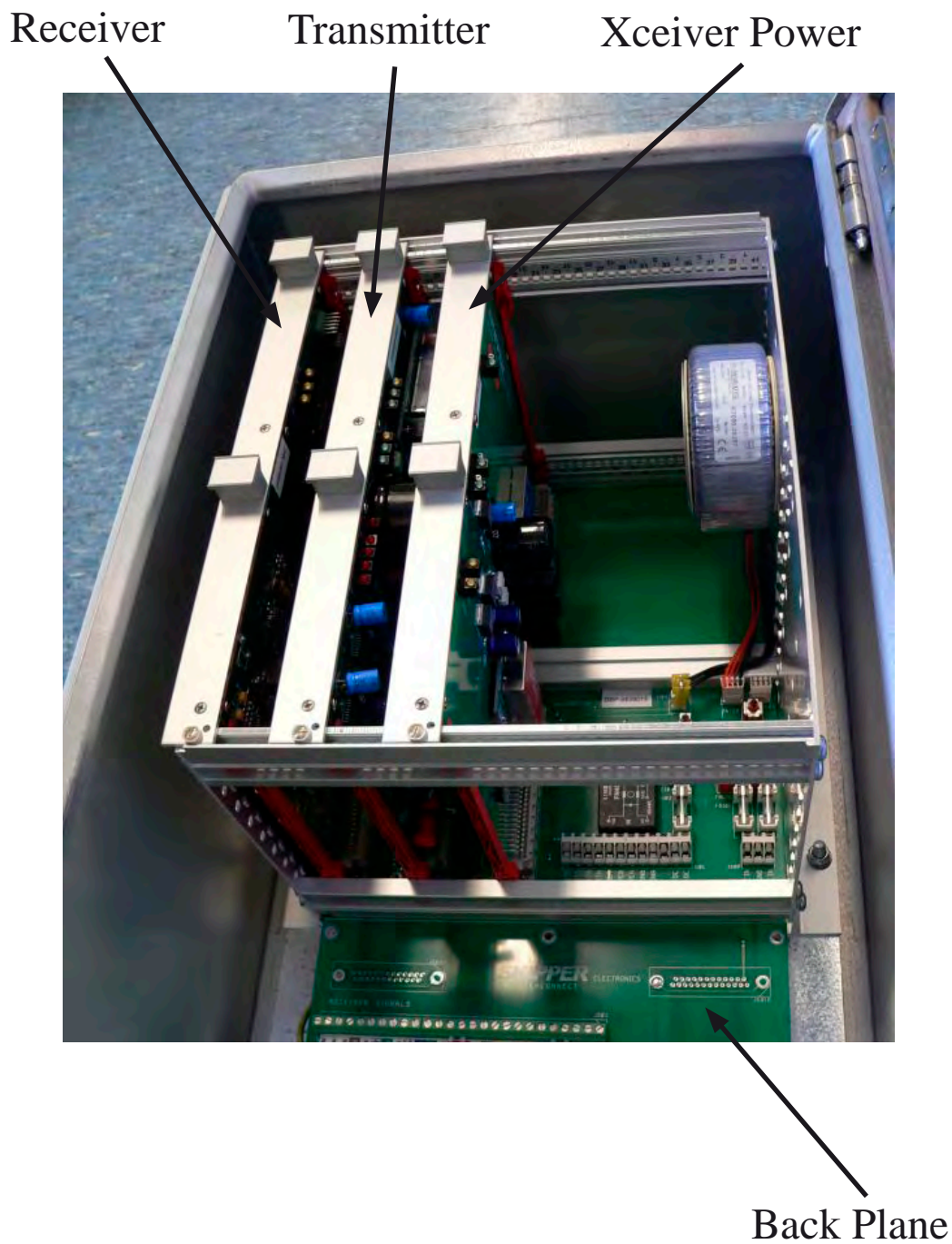
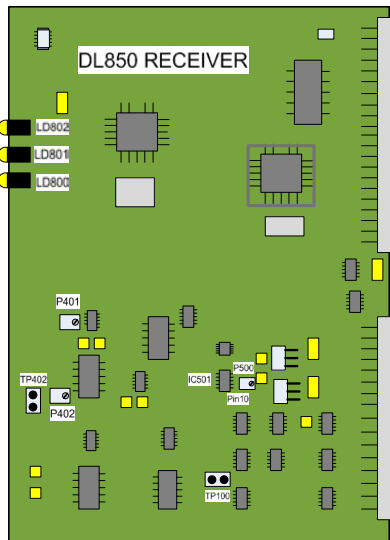





Fig. 10.1 PCB positions in Transceiver Unit

LEDs on PCBs in Transceiver Unit







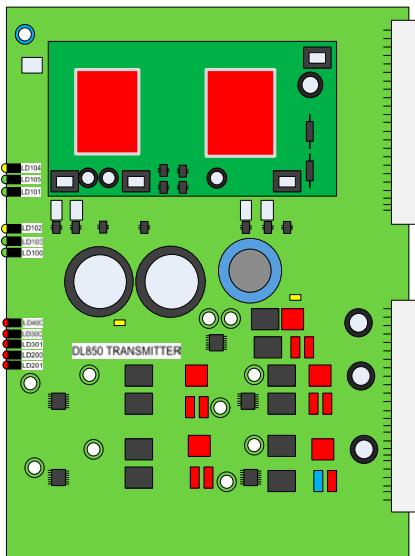

LEDs on Receiver Board

-  LD 802: CPU Reset
-  LD 801: Transmit Data
-  LD 800: Program Download



LEDs on Transmitter Board

-  LD104: Echo Sounder 100 % Power
-  LD105: Echo Sounder 25 % Power
-  LD101: Echo Sounder Power active
-  LD102: Speed Log 100 % Power
-  LD103: Speed Log 25 % Power
-  LD100: Speed Log Power active
-  LD400: Ch 5 active } Channel 5:
270: Not Used (GND)
540: ES (Echosounder)
-  LD300: Ch 3 active } Channel 3:
270: Strb Aft
540: Strb
-  LD301: Ch 4 active } Channel 4:
270: Port Aft
540: Port
-  LD200: Ch 1 active } Channel 1:
270: Fore
540: Fore
-  LD201: Ch 2 active } Channel 2:
270: Not Used (GND)
540: Aft

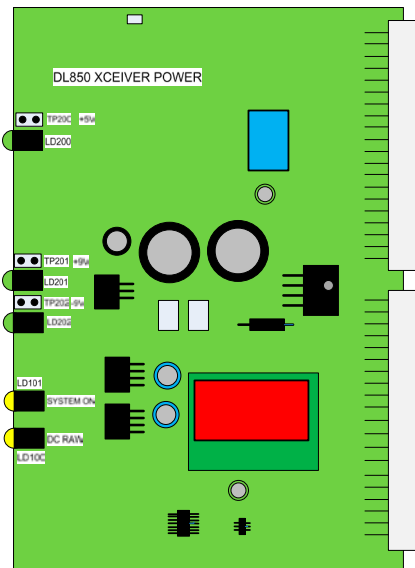

LEDs on Power Board





-  LD 200: +5V
-  LD201: +9V
-  LD202: -9V
-  LD101: System On
-  LD100: DC Raw

Fig. 10.2 LEDs on PCBs in Transceiver Unit

DL 850 System Overview

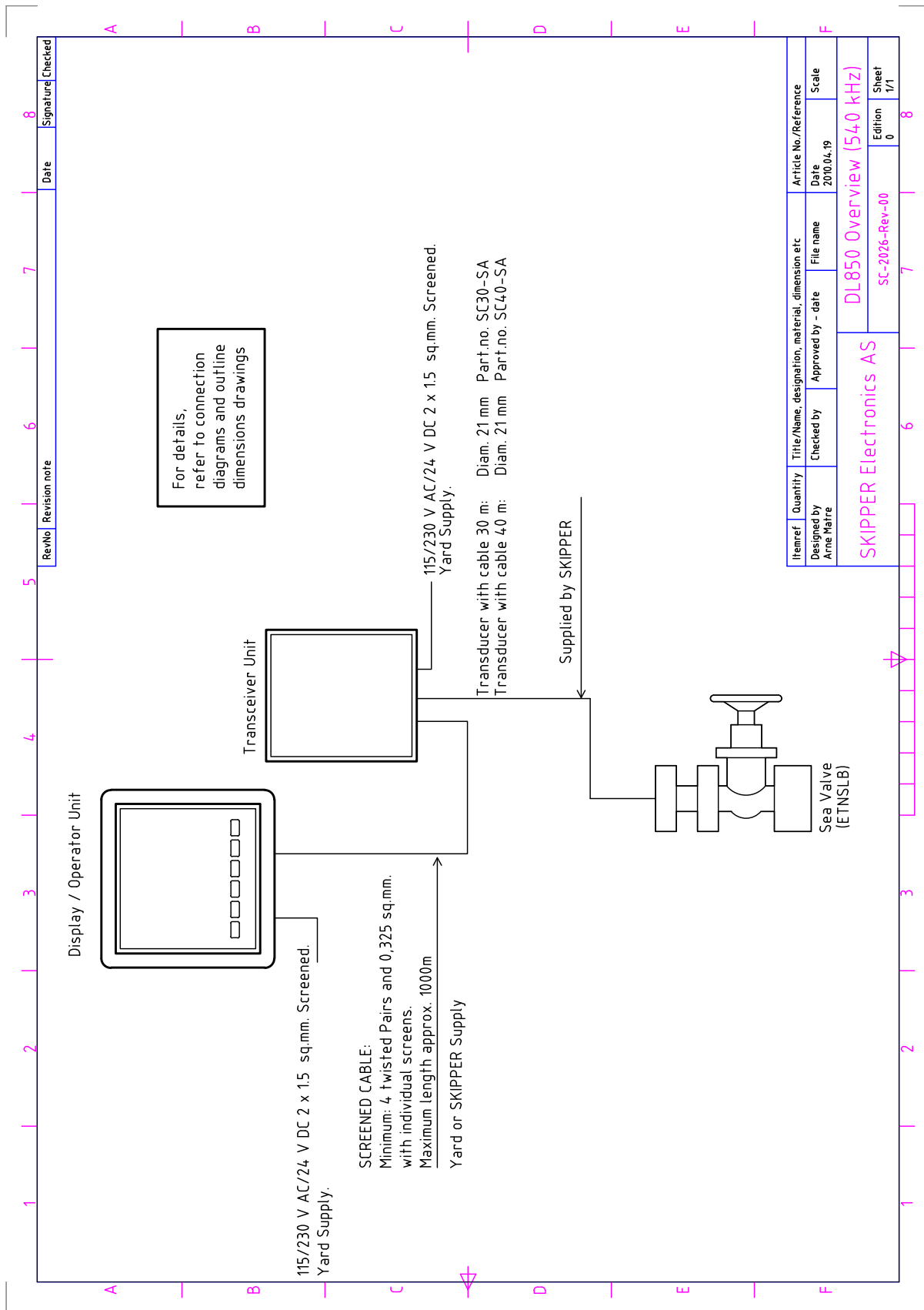

Fig. 10.3. System overview

Operator Unit - Transceiver Unit Interconnection

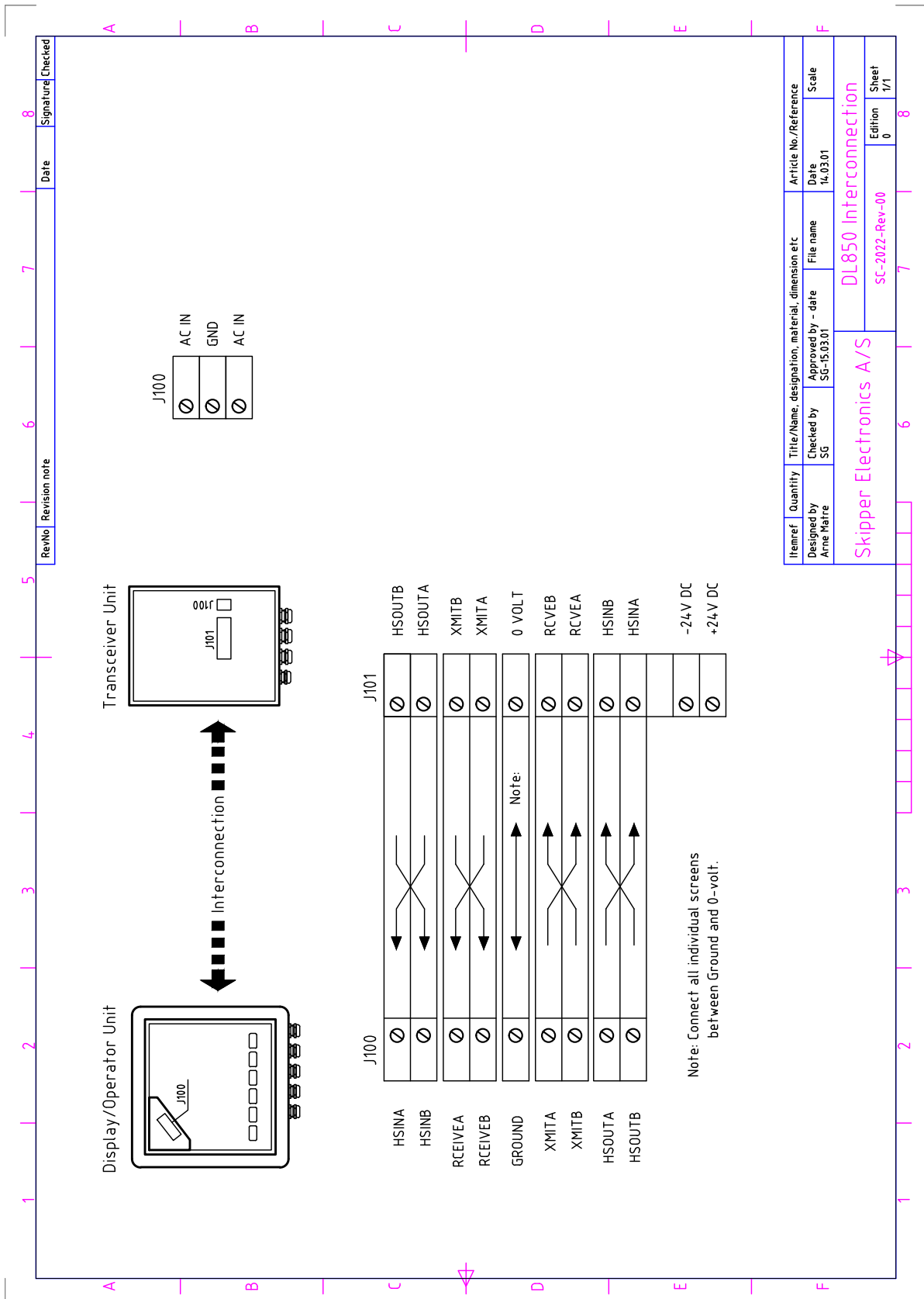

Fig. 10.4. Transceiver unit - operator unit interconnection

540 kHz Sensor Cable Connection

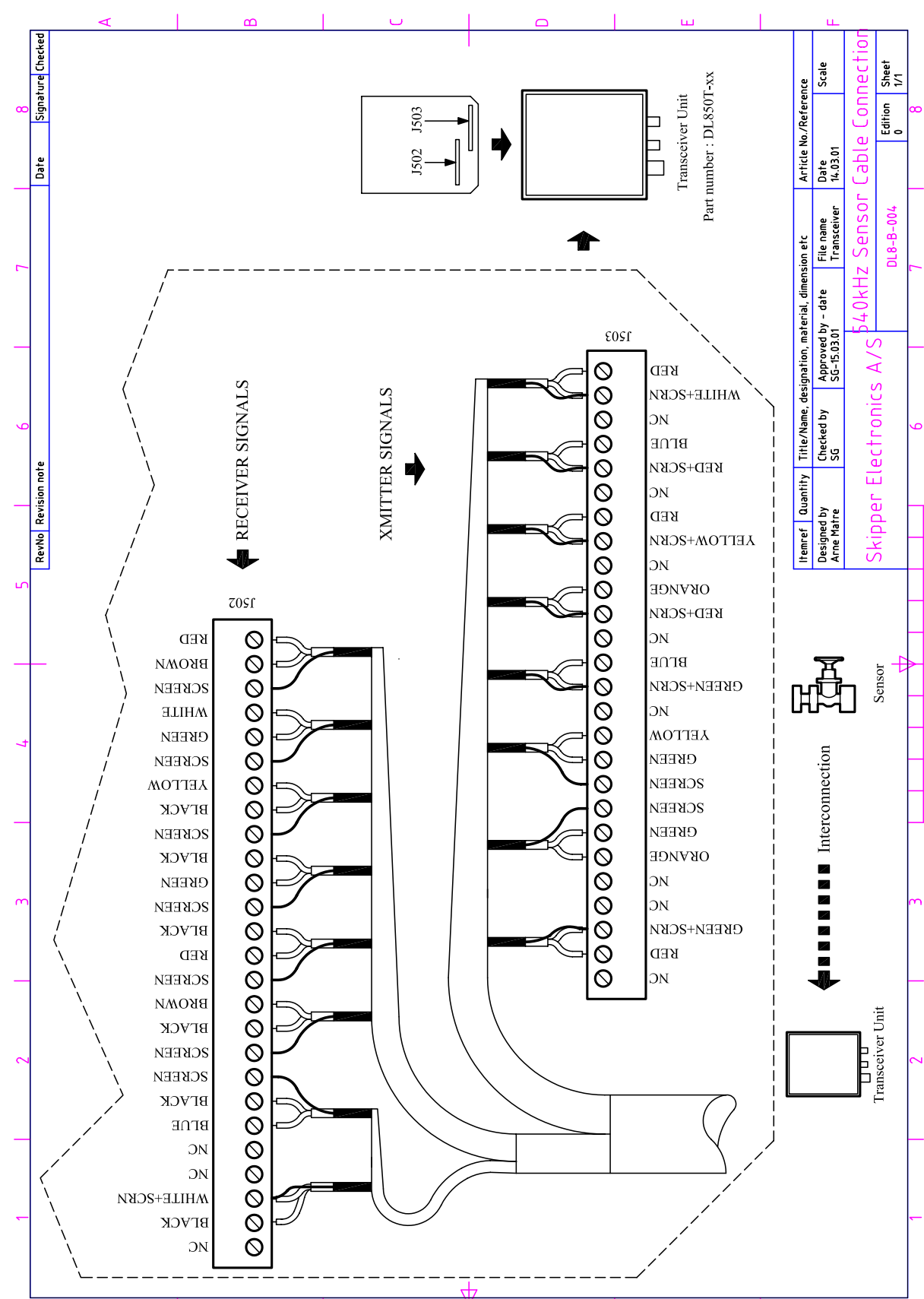

Fig. 10.5. 540 kHz Sensor Cable Connection

Itemref	Quantity	Title/Name, designation, material, dimension etc	Article No./Reference
Designed by Arne Hårrre		Approved by - date SG-15/03/01	Date 14/03/01
Checked by SG		File name Transceiver	Scale

540kHz Sensor Cable Connection

DL8-B-004	Edition 0	Sheet 1/1
-----------	--------------	--------------

RevNo	Revision note	Date	Signature	Checked
8				

Transceiver Unit Dimensions

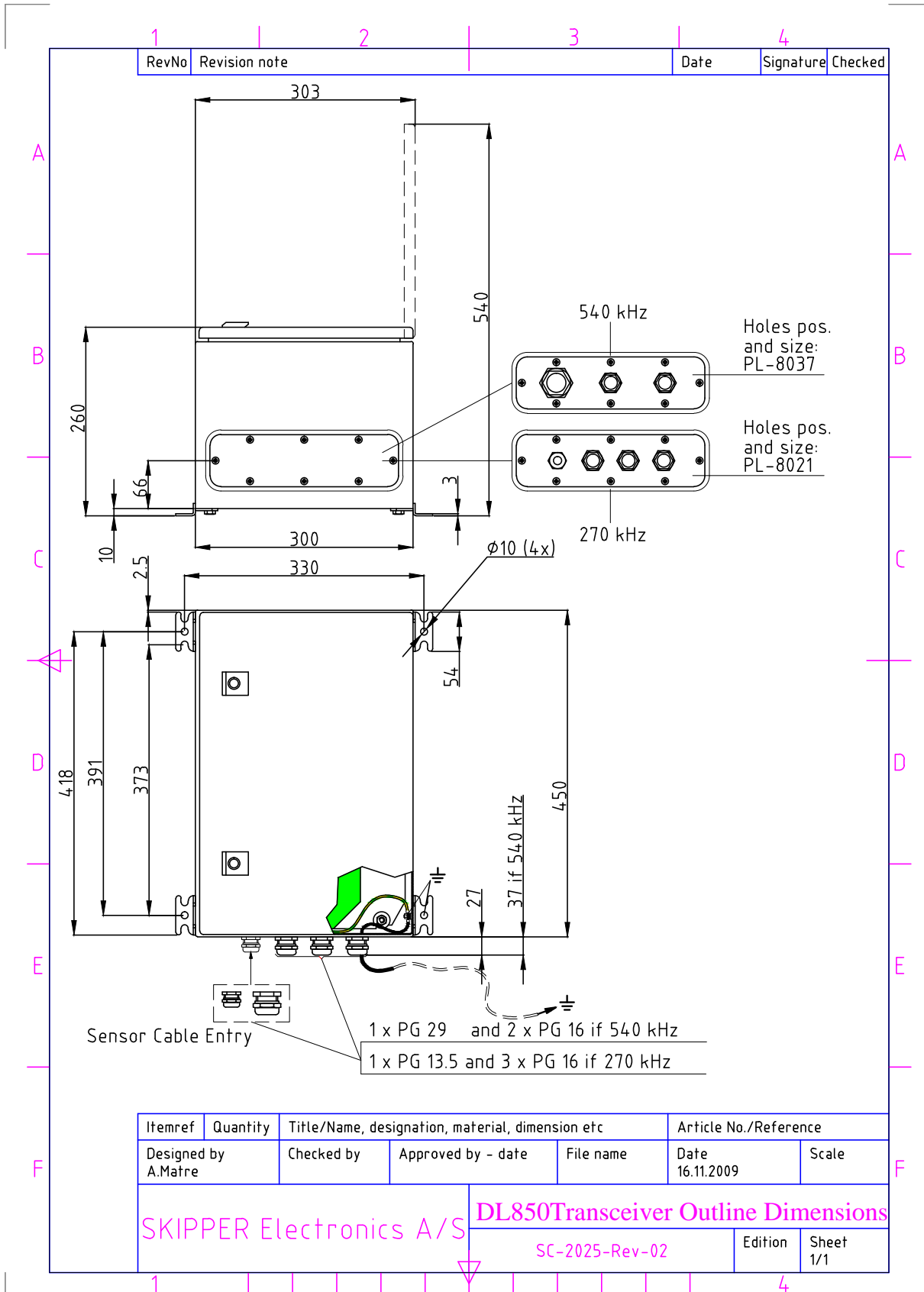

Fig. 10.6. Transceiver Unit Dimensions

Dimensional Drawing Cabinet

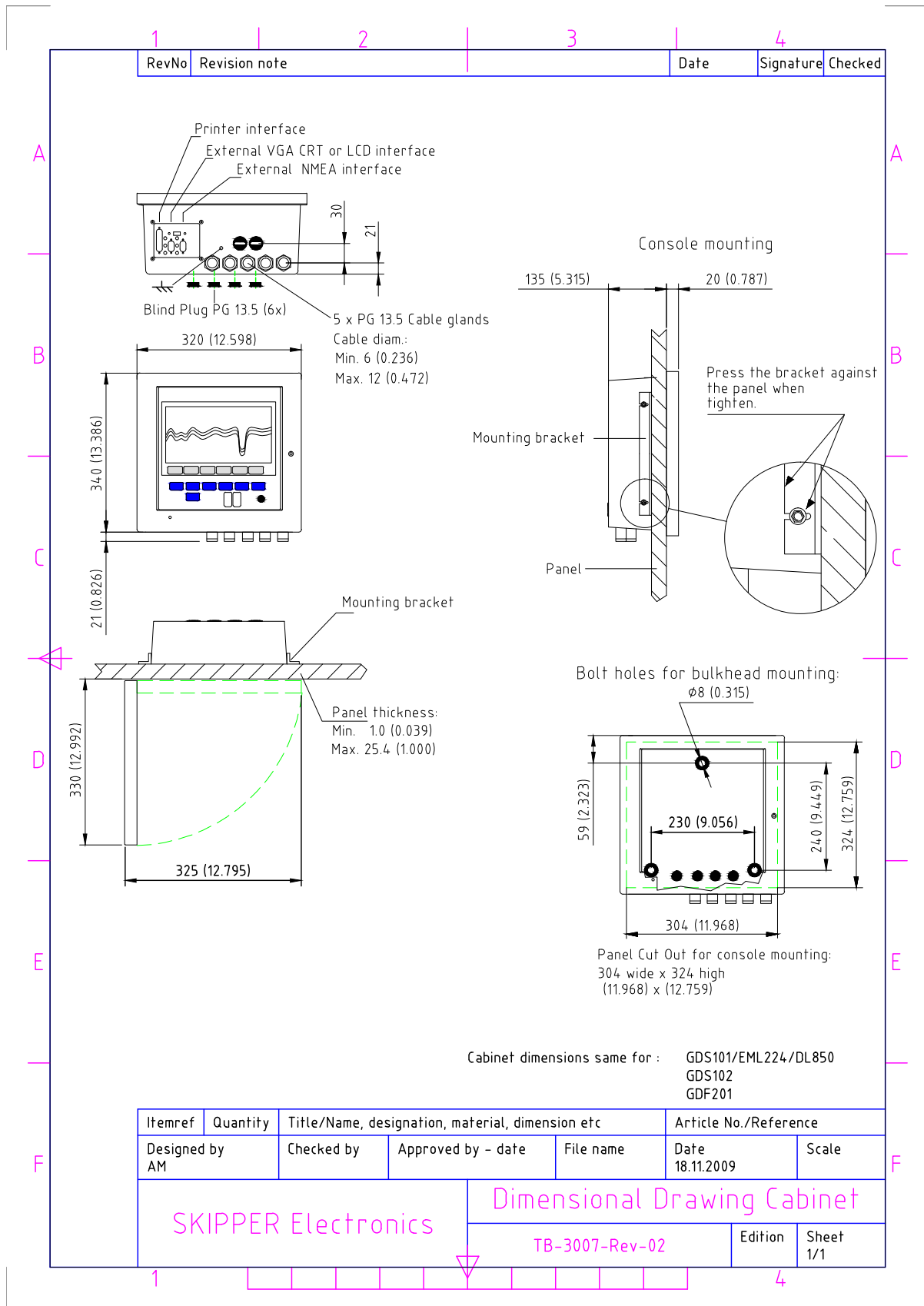
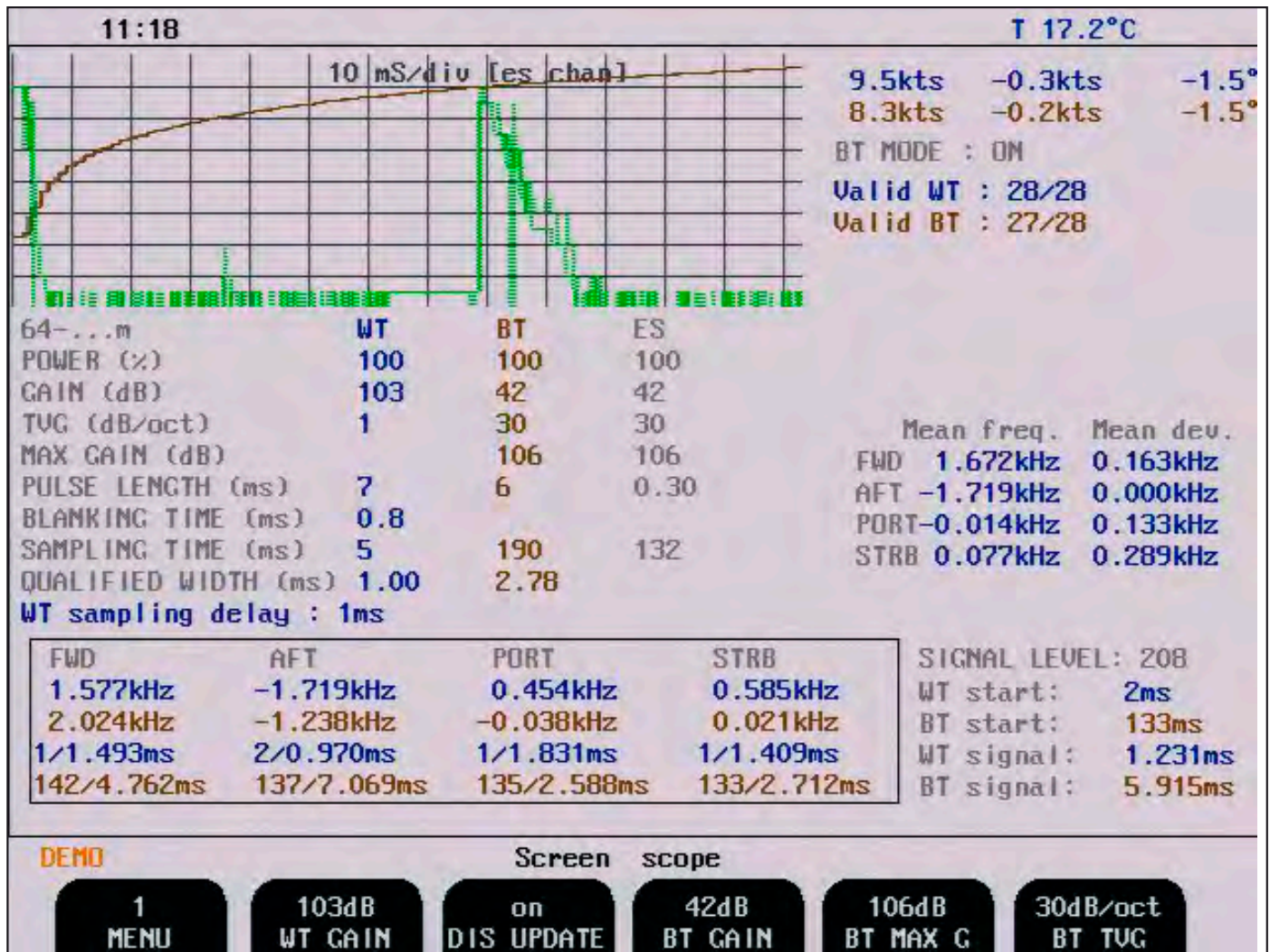

Fig. 10.7. Cabinet Dimensions

11. Appendix 2

Screen scope settings

As explained in the diagnostics section, the screen scope allows the user to adjust the optimized defaults for each depth band. This is not recommended as it may impede the performance of the unit. This section describes the functionality of all the buttons available. These options are activated by waiting for two beeps, when pressing the hidden button



Screen scope, Menu 1, gain/TVG.

Soft key	Name	Range/value	Default value	Description	Activate with hidden button
1	MENU	1 - 6	1	Menu 1 is selected.	
2	WT GAIN	17 - 106 dB	103 dB	Water track start gain (at a time when receiver is open).	Yes
3	DIS UPDATE	On/Off	On	Toggle display update on/off.	
4	BT GAIN	17 - 105 dB	42 dB	Bottom track start gain (at a time when receiver is open).	Yes
5	BT MAX G	18 - 106 dB	106 dB	Max gain for bottom track.	Yes
6	BT TVG	5 - 50 dB/oct	30 dB/oct	Bottom track time variable gain expressed in decibel (dB)/oct. Note: "oct" is 100 m of range.	Yes



Screen scope, Menu 2, range/BT settings.

Soft key	Name	Range/value	Default value	Description	Activate with hidden button
1	MENU	1 - 6	2	Menu 2 is selected.	
2	SL RANGE	1 - 5 m, 5 - 10 m, 10 - 15 m, 15 - 25 m, 25 - 40 m, 40 - 64 m, 64 ---- m,	1 - 5 m	Select speed log range for adjustments of the set of the transceiver parameters. During operation, the software will automatically activate the set of parameters which corresponds with the actual range (depth below transducer). Note: When the operator changes SL RANGE, the rest of the soft keys will change their values according to the currently set SL RANGE.	
3	BT PULSE	1 - 30 ms	1 - 5 m: 3 ms, 5 - 10 m: 4 ms, 10 - 15 m: 6 ms, 15 - 25 m: 8 ms, 25 - 40 m: 10 ms, 40 - 64 m: 8 ms, 64 - m: 6 ms,	Pulse length during bottom track sample which corresponds to different range (SL RANGE).	Yes
4	BT Q WIDTH	0.02 - 55.56 ms	1 - 5 m: 2,78 ms, 5 - 10 m: 2.78 ms, 10 - 15 m: 4,44 ms, 15 - 25 m: 4.44 ms, 25 - 40 m: 4.44 ms, 40 - 64 m: 5.00 ms, 64 - m: 2,78 ms,	Bottom track signal width discrimination factor which corresponds to different range (SL RANGE). Minimum echo signal width in BT mode to qualify this signal as acceptable for further calculations.	Yes
5				Not used.	
6	SL POWER	10 %, 25 %, 100 %	100 %	Speed log transmitter power.	Yes

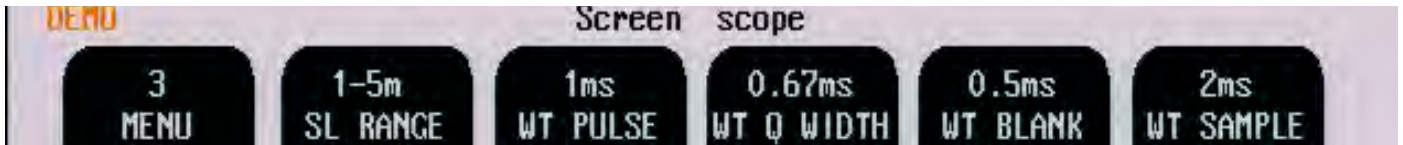

Screen scope, Menu 3, range/WT settings.

Soft key	Name	Range/value	Default value	Description	Activate with hidden button
1	MENU	1 - 6	3	Menu 3 is selected.	
2	SL RANGE	1 - 5 m, 5 - 10 m, 10 - 15 m, 15 - 25 m, 25 - 40 m, 40 - 64 m, 64 ---- m,	1 - 5 m	Select speed log range for adjustments of the transceiver parameters. During operation, the software will automatically activate the set of parameters which corresponds with the actual range (depth below transducer). Note: When the operator changes SL RANGE, the rest of the soft keys will change their values according to the currently set SL RANGE.	
3	WT PULSE	1 - 30 ms	1 - 5 m: 1 ms, 5 - 10 m: 3 ms, 10 - 15 m: 4 ms, 15 - 25 m: 6 ms, 25 - 40 m: 6 ms, 40 - 64 m: 6ms, 64 - m: 7 ms,	Pulse length during water track sample which corresponds to different range (SL RANGE).	Yes
4	WT Q WIDTH	0.02 - 55.56 ms	1 - 5 m: 0.67 ms, 5 - 10 m: 0.78 ms, 10 - 15 m: 0.78 ms, 15 - 25 m: 1.00 ms, 25 - 40 m: 1.00 ms, 40 - 64 m: 1.00 ms, 64 - m: 1.00 ms,	Water track signal width discrimination factor which corresponds to different range (SL RANGE). Minimum echo signal width in WT mode to qualify this signal as acceptable for further calculations.	Yes
5	WT BLANK	0.1 - 25.0 ms	1 - 5 m: 0.5 ms, 5 - 10 m: 0.8 ms, 10 - 15 m: 0.8 ms, 15 - 25 m: 0.8 ms, 25 - 40 m: 0.8 ms, 40 - 64 m: 0.8 ms, 64 - m: 0.8 ms,	Time delay between end of transmission and opening receiver. Actually this parameter defines the distance from the hull, where speed measurements begin.	Yes
6	WT SAMPLE	1 - 150 ms	1 - 5 m: 2 ms, 5 - 10 m: 2 ms, 10 - 15 m: 4 ms, 15 - 25 m: 6 ms, 25 - 40 m: 6 ms, 40 - 64 m: 6 ms, 64 - m: 5 ms,	Period of time, when receiver is kept open.	Yes

Example: If it is necessary to adjust WT BLANK parameter, when the boat is operating at 15 - 25 m depth range, first select this range by using the SL RANGE soft key and then, with the encoder, set the desired value. Same procedure should be repeated for other ranges (if required).

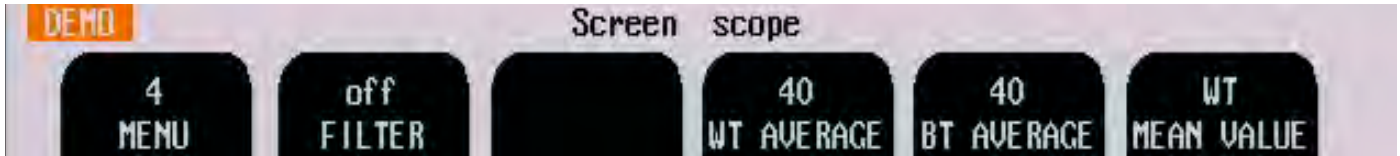

Screen scope, Menu 4, filtering/averaging.

Soft key	Name	Range/value	Default value	Description	Activate with hidden button
1	MENU	1 - 6	4	Menu 4 is selected.	
2	FILTER	On/off	Off	Selects speed filtering parameters. This is a simple running average taking the user selectable number of points and averaging these to give the output result.	Yes
3				Not used	
4	WT AVERAGE	1 - 100	40	Number of individual samples to be averaged in WT mode to provide better accuracy.	Yes
5	BT AVERAGE	1 - 100	40	Number of individual samples to be averaged in BT mode to provide better accuracy.	Yes
6	MEAN VALUE	BT/WT	WT	Toggle between WT and BT for the information showing mean frequency and deviation for last 100 samples.	

IMPORTANT NOTE: In case of accidental changing of some parameters, which causes serious malfunction, reset all parameters to factory defaults. To do this, it is necessary to switch power off and on again. Press the left and right soft keys in the upper row and keep them pressed until the graphic picture appears on the screen. 4 beeps are provided; signaling that master reset operation has been completed. Remember, that in this case, all previously set parameters (analogue ranges, NMEA message outputs etc.) must be repeated.



Screen scope, Menu 5, general settings/recording.

Soft key	Name	Range/value	Default value	Description	Activate with hidden button
1	MENU	1 - 6	5	Menu 5 is selected.	
2	DPT RANGE	10 - 200	100 m	Echo sounder depth range.	
3				Not used	
4				Not used	
5				Not used	
6	RECORDINGS	On/off	Off	Diagnostic recording	Yes



Screen scope, Menu 6, mode settings.

Soft key	Name	Range/value	Default value	Description	Activate with hidden button
1	MENU	1 - 6	6	Menu 6 is selected.	
2	ES MODE	On/Off	On	Toggles ES MODE (Echo Sounder) on/off.	Yes
3	SL WT MODE	On/Off	On	Can be used for trouble shooting. Must be switched on at normal operation.	Yes
4	SL BT MODE	On/Off	On	Can be used for trouble shooting and factory testing. Must be switched on at normal operation.	Yes, active if AUTO BT is off.
5	AUTO BT	On/Off	On	Toggle automatic bottom track. If switched on, bottom track sampling rate is automatically reduced if the present water depth is greater than bottom track operating range. If AUTO BT is switched off, bottom track function will operate continuously, but still only give BT speed indications within the range for bottom track.	Yes
6	SYSTEM	On/Off	On	Turn system off.	

12. Appendix 3

Upgrading Software

New software versions are released from time to time. The DL850 with Compact Flash (CF) can be updated by performing the following software upgrade procedure.

1. If you have received a programmed compact flash, skip stage 2.
2. Copy the received/downloaded software file into the root folder of Compact Flash card. The name of the file is not relevant. Also copy the latest version of setup.exe into the root folder.

Note: Standard Compact Flash reader is needed to be attached to the PC.

Note: It is possible to use the Compact Flash card, which is already installed in the display unit.

3. Switch OFF the mains of the display unit and insert Compact Flash card with the new software on it.
4. Press the “hidden” button inside the cabinet (mounted on the solder side of the keyboard). Keeping the hidden button pressed, switch ON the mains in the display unit and keep the button pressed while the message “You may release the hidden button” appears in the lower part of the screen. If a new setup.exe is to be loaded, follow the on screen instructions.
5. Release the hidden button. After few diagnostic text messages, the list of available software versions will appear in the lower part of the screen as in example below.
6. Note: If the bootloader does not find any file with the software on the Compact Flash, the presently installed version will start automatically. In this case, make sure, that the upgrade and setup file has been copied correctly on the Compact Flash and repeat procedure.

4.01.08	4.01.11				
Active	External				
KEY 1	KEY 2	KEY 3	KEY 4	KEY 5	KEY 6

7. Select a software version, which you would like to install. Normally, it is possible to chose one out of two: the version, which is currently installed in the internal memory (indicated as Active) and the upgrade version (indicated as External). The version name is displayed in the upper line of the text lines, located just above the corresponding soft key. In the example above, soft key #2 should be pressed to select the latest software version.
8. Confirm selection by pressing YES button (or go back to selection, pressing NO).
9. Press any button to start the upgraded software (or it will start automatically in 5 seconds).
10. Note: The file with a previous software version will be copied back to the Compact Flash card, so it would be possible to re-install it in the similar manner, if desired.